

KULINARISK

cs

et

fi

el

lv

lt

pl

sk

sv



Design and Quality
IKEA of Sweden

ČESKY	6
EESTI	10
SUOMI	14
ΕΛΛΗΝΙΚΑ	18
LATVIEŠU	22
LIETUVIŲ	26
POLSKI	30
SLOVENSKY	34
SVENSKA	38

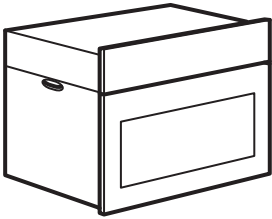
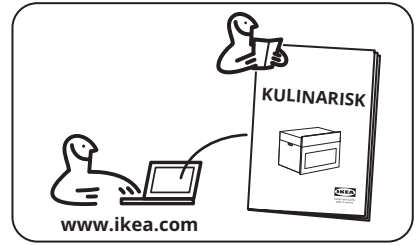
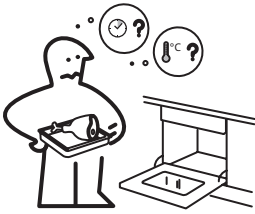

1x

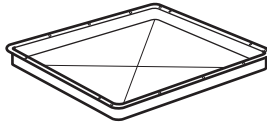

1x



1x



1x

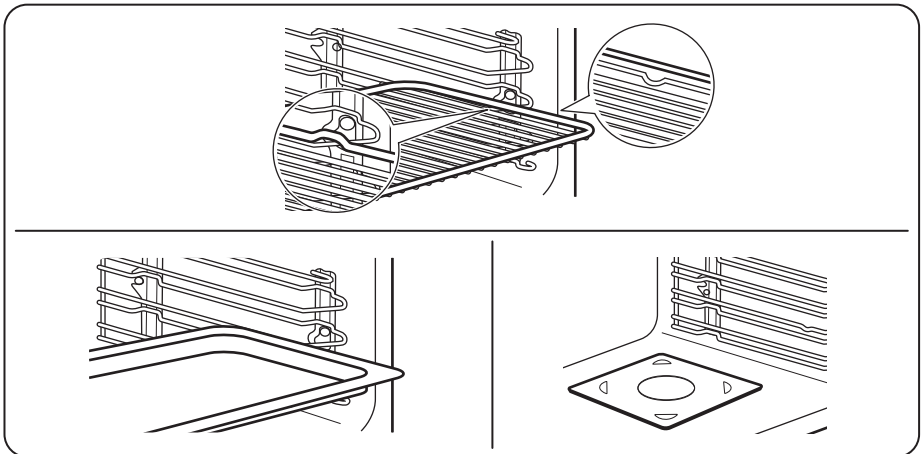

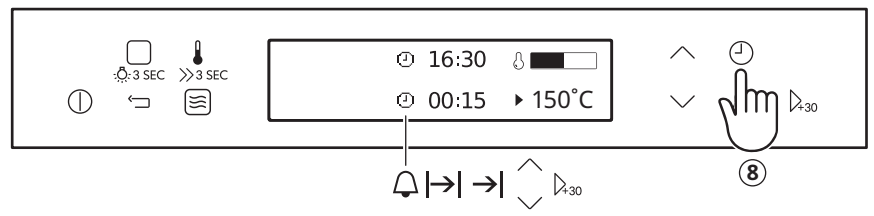
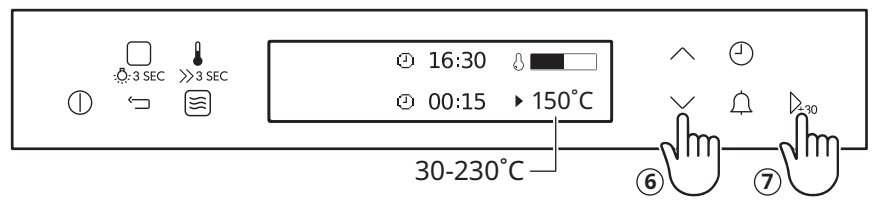
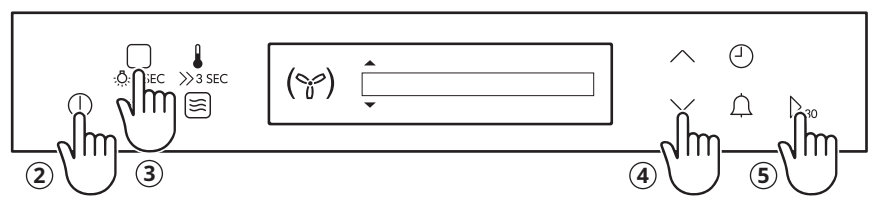
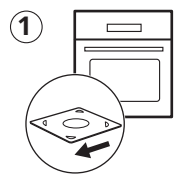
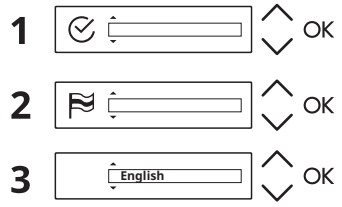
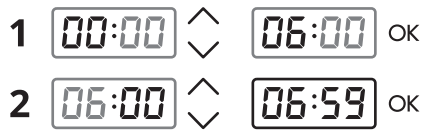
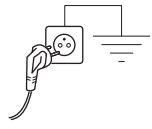

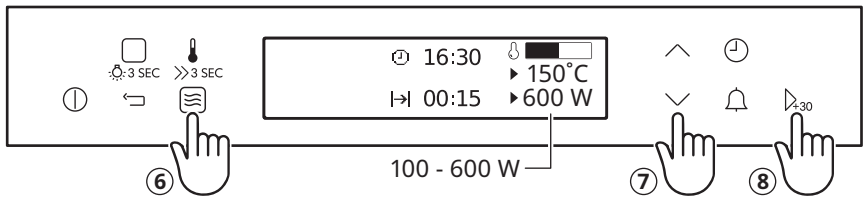
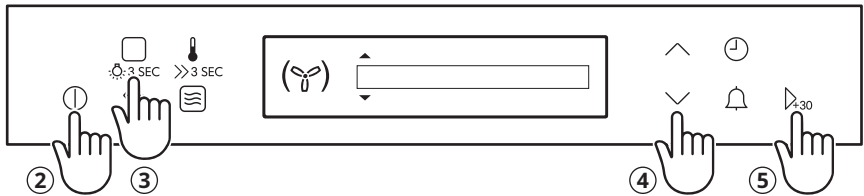
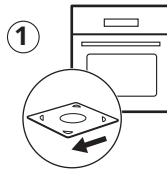
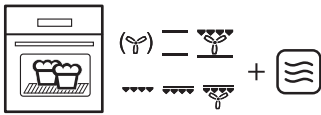
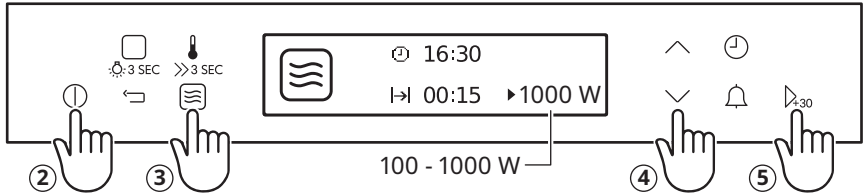
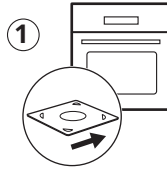

Popis výrobku

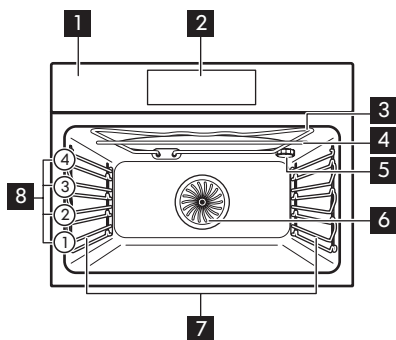

- 1** Ovládací panel
- 2** Elektronický programátor
- 3** Gril
- 4** Generátor mikrovln
- 5** Osvětlení
- 6** Ventilátor
- 7** Zasouvací mřížka, vyjímatelné
- 8** Polohy mřížky

Ovládací panel

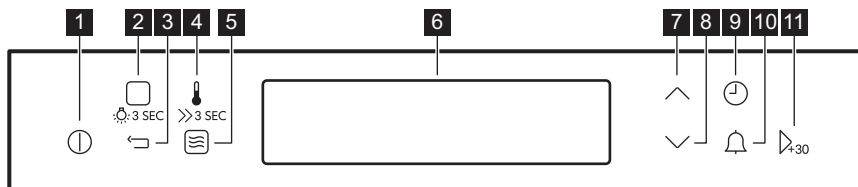





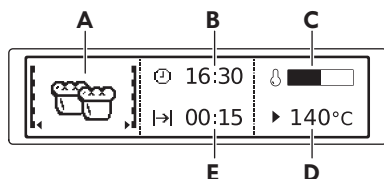





- 1** ZAP/VYP
- 2** Pečicí funkce / Podporované Vaření / kontrolka
- 3** Tlačítko Zpět
- 4** Teplota / Rychlé zahřátí
- 5** Funkce mikrovlnné trouby
- 6** Displej
- 7** Tlačítko nahoru
- 8** Tlačítko dolů
- 9** Funkce Čas / Více
- 10** Minutka
- 11** OK / Rychlý start mikrovlnné trouby

Displej











- A.** Pečicí funkce nebo mikrovlnná funkce
- B.** Denní čas
- C.** Ukazatel zahřívání
- D.** Teplota nebo výkon mikrovln
- E.** Zobrazuje dobu pečení nebo čas do konce funkce







Ostatní kontrolky na displeji:

Symbol	Funkce
	Funkce je zapnutá.
	Zobrazuje aktuální čas.
	Zobrazuje čas potřebný k přípravě pokrmu.
	Zobrazuje dobu trvání pečení.
	Zobrazuje teplotu.
	Zobrazuje uplynutí nastavené doby přípravy. Čas vynulujete stisknutím \vee a \wedge současně.
	Ukazuje teplotu v troubě.
	Rychlé zahřátí je zapnuté.
	Ukazuje, že je zapnutá funkce Automatická váha nebo že můžete změnit nastavení váhy
	Funkce Ohřev a uchování teploty je zapnutá.

Pečicí funkce

	Pravý horký vzduch	Rovnoměrné pečení, křehkost, sušení
	Horní/spodní ohřev	Tradiční pečení
	Funkce pizzy	Příprava pizzy
	Nízkoteplotní pečení	Pro křehké pečeně
	Spodní ohřev	Pečení dortů
	Mražené potraviny	Pro polotovary (např. hranolky)
	Gril	Grilování, opékání
	Rychlý gril	Grilování velkých porcí, opékání
	Turbo gril	Pečení masa, opékání

Speciality

	Pečení chleba		Kynutí těsta		Zavařování		Uchovat teplé
	Gratinované pokrmy		Ohřev talířů		Dehydratace		Rozmrazování

Nádobí a materiály vhodné do mikrovlnné trouby

V mikrovlnné troubě používejte výhradně vhodné nádobí a materiály. Řiďte se údaji v tabulce níže.

Před použitím ověřte technické údaje nádobí/materiálu.

Nádobí/materiál	Funkce mikrovlnné trouby		Kombinovaná mikrovlnná funkce
	Rozmrazování	Ohřev Pečení	
Žárovzdorné sklo a porcelán bez kovových dílů	✓	✓	✓
Nežárovzdorné sklo a porcelán bez stříbrných, zlatých, platinových nebo jiných kovových dekorací	✓	X	X
Sklo a sklokeramika z ohnivzdorného a mrazuvzdorného materiálu	✓	✓	✓
Keramika a kamenina bez skleněných nebo kovových částí a bez glazury s obsahem kovu	✓	✓	X
Keramika, porcelán a kamenina s neglazovaným dnem nebo s malými dírkami, např. na rukojetích	X	X	X
Plast, žárovzdorný do 200 °C	✓	✓	X
Karton, papír	✓	X	X
Potravinová fólie	✓	X	X
Fólie na pečení s uzávěrem vhodným pro mikrovlnnou troubu	✓	✓	X
Pečicí nádoby vyrobené z kovu, např. smalt, litina	X	X	✓
Formy na pečení, černě lakované nebo se silikonovou vrstvou	X	X	✓
Plech na pečení	X	X	X
Tvarovaný rošt	X	X	✓
Skleněný talíř mikrovlnné trouby	✓	✓	X
Nádoby do mikrovlnné trouby, například pražicí pánvička	X	✓	X

Odstraňování závad

V případě problémů se spotřebičem se podívejte do kapitoly „Odstraňování závad“

v plné verzi návodu k použití, který naleznete na adrese: www.ikea.com.

Technické údaje

Rozměry (vnitřní)	Šířka Výška Hloubka	480 mm 217 mm 411 mm
Využitelný objem	43 l	
Plocha plechu na pečení	1424 cm ²	
Horní topný článek	1900 W	
Dolní topný článek	1000 W	
Gril	1 900 W	
Okruh	1 650 W	
Celkový jmenovitý výkon	3000 W	
Napětí	220 - 240 V	
Frekvence	50 Hz	
Počet funkcí	17	

Toote kirjeldus

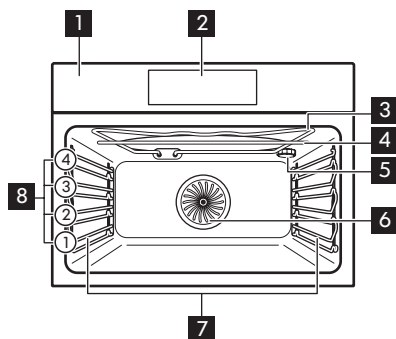

- 1** Juhtpaneel
- 2** Elektronprogrammeerija
- 3** Grill
- 4** Mikrolaine generaator
- 5** Lamp
- 6** Ventilator
- 7** Riiulitugi, eemaldatav
- 8** Riiuli asendid

Juhtpaneel

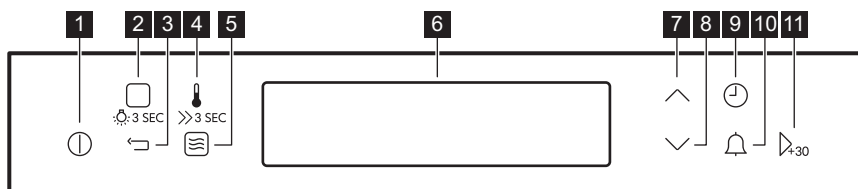





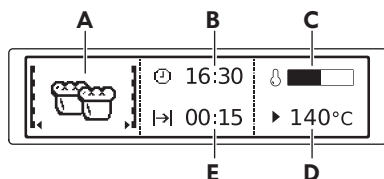

- 1** SEES/VÄLJAS
- 2** Kõpsetusrežiimid / Juhendatud Kõpsetamine / Lamp
- 3** Tagasi
- 4** Temperatuur / Kiirkuumus
- 5** Mikrolainefunktsioon
- 6** Ekraan
- 7** Üles
- 8** Alla
- 9** Aeg / Rohkem funktsioone
- 10** Minutilugeja
- 11** OK / Mikrolaineahju kiirkäivitus

Ekraan











- A.** Kuumutamise või mikrolaine funktsioon
- B.** Kellaeg
- C.** Kuumutusindikaator
- D.** Mikrolaine temperatuur või võimsus
- E.** Funktsiooni kestus või lõpuaeg









Muud ekraani näidikud:

Sümbol	Funktsioon
	Funktsioon on sees.
	Näitab jooksvat aega.
	Näitab vajalikku küpsetusaega.
	Näitab toiduvalmistamise kestust.
	Näitab temperatuuri.
	Näitab, kui valitud küpsetusaeg lõpeb. Aja lähtestamiseks vajutage korraga nuppe \vee ja \wedge .
	Näitab ahju kuumustaset.
	Kiirkuumutus on sisse lülitatud.
	Näitab, et automaatse kaalumise funktsioon on sisse lülitatud või et saate kaalu seadistust muuta
	Kuumutamine + Temperatuuri hoidmine on sees.

Küpsetusrežiimid

	Pöördõhk	Ühtlane küpsetamine, õrn tulemus, kuivatamine
	Ülemine + alumine kuumutus	Traditsiooniline küpsetamine
	Pitsa funktsioon	Pitsa küpsetamine
	Küpsetamine madalal t°	Õrnaks röstimiseks
	Alumine kuumus	Kookide küpsetamine
	Külmutatud toiduained	Mugavustoituledele (nt friikartulitele)
	Grill	Röstimine, grillimine
	Kiirgrill	Suurte portsjonite grillimine, röstimine
	Turbogrill	Liha küpsetamine, pruunistamine

Muu

	Leib		Taina kergitamine		Hoidistamine		Soojashoidmine
	Gratineerimine		Nõude soojendamine		Dehüdratsioon		Sulatamine

Mikrolaineahju sobivad nõud ja materjalid

Mikrolainefunktsiooni kasutamisel tarvitage ainult sobivaid nõusid ja materjale. Kasutage viitena allolevat tabelit.

Kontrollige nõusid/nõude materjali enne kasutamist.

Keedunõu/materjal	Mikrolainefunktsioon		Mikrolaine-kombi-funktsioon
	Ülessulata-mine	Kuumutamine, Küpsetamine	
Ahjukindel klaas ja portselan ilma metalloseta, nt kuumakindel klaas	✓	✓	✓
Mitte-ahjukindel klaas ja portselan ilma hõbedast, kullast, platinast või metallist katete/kaunistusteta	✓	X	X
Ahjukindel/külmumiskindel klaas ja klaaskeraamika	✓	✓	✓
Keraamika ja savinõud ilma kvarts- või metalloseta või metallisisalduseta glasuurita	✓	✓	X
Keraamika, portselan ja savinõud glasuurita põhjaga või väikeste aukudega, nt käepidemetel	X	X	X
Kuumakindel plastik kuni 200 °C	✓	✓	X
Papp, paber	✓	X	X
Säilituskile	✓	X	X
Küpsetuskile mikrolainekindla sulguriga	✓	✓	X
Metallist nõudega röstimine, nt email, malm	X	X	✓
Küpsetusvormid, musta email- või sili-koonkattega	X	X	✓
Küpsetusplaat	X	X	X
Traatrest	X	X	✓
Mikrolaineahju klaasist alus	✓	✓	X
Mikrolaineahjus kasutamiseks mõeldud nõud, nt kröbestamisalus	X	✓	X

Tõrkeotsing

Kui teil on seadmega probleeme, kontrollige kasutusjuhendi täisversiooni peatükki

„Tõrkeotsing“, mis on saadaval aadressil: www.ikea.com.

Tehnilised andmed

Mõõtmed (sisemised)	Laius Kõrgus Sügavus	480 mm 217 mm 411 mm
Kasutatavad mahud	43 l	
Küpsetusplaadi ala	1424 cm ²	
Ülemine kuumutuselement	1900 W	
Alumine kuumutuselement	1000 W	
Grill	1900 W	
Ring	1650 W	
Summaarne nimivõimsus	3000 W	
Pinge	220 - 240 V	
Sagedus	50 Hz	
Funktsioonide arv	17	

Tuotekuvaus

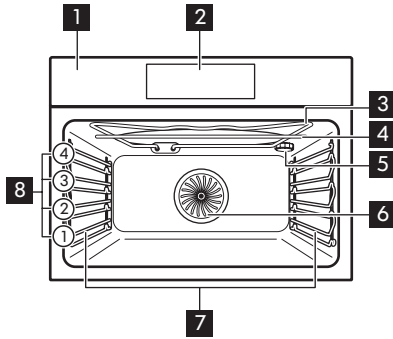

- 1** Käyttöpaneeli
- 2** Elektroninen ohjelmointilaite
- 3** Grilli
- 4** Mikroaaltogeneraattori
- 5** Lamppu
- 6** Puhallin
- 7** Hyllykannatin, irrotettava
- 8** Hyllytasot

Ohjauspaneeli

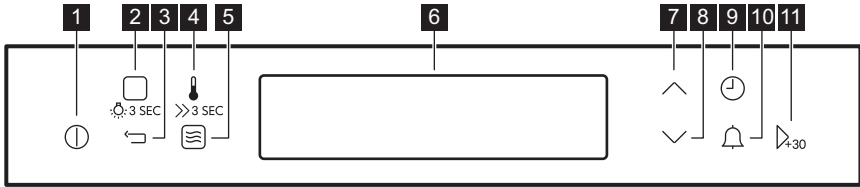





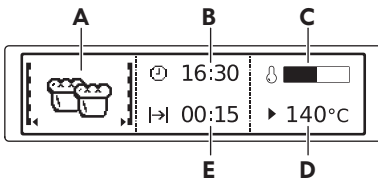





- 1** ON (Päälle) / OFF (Pois päältä)
- 2** Uunitoiminnot / Avustava Ruoanvalmistus / Lamppu
- 3** Takaisin-painike
- 4** Lämpötila / Pikakuuminen
- 5** Mikroaaltotoiminto
- 6** Näyttö
- 7** Ylös-näppäin
- 8** Alas-näppäin
- 9** Aika / Lisää toimintoja
- 10** Hälytinajastin
- 11** OK / Mikroaaltouunin pikakäynnistys

Näyttö











- A.** Uunitoiminto tai Mikroaaltotoiminto
- B.** Kellonaika
- C.** Kuumennuksen merkkivalo
- D.** Lämpötila tai mikroaaltoteho
- E.** Toiminnon kesto tai päättymisaika

Muut näytön merkkivalot:

Merkki	Toiminto
	Toiminto on päällä.
	Näyttää kuluvan ajan.
	Näyttää vaaditun kypsennysajan.
	Näyttää kypsennyksen keston.
	Näyttää lämpötilan.
	Näyttää, milloin asetettu kypsennysaika loppuu. Nollaa aika painamalla samanaikaisesti \vee ja \wedge .
	Osoittaa uunin lämpötason.
	Pikakuumennus on päällä.
	Näyttää, että painoautomaatiikkatoiminto on päällä tai että voit muuttaa painoasetusta
	Valmista ja pidä on päällä.

Uunitoiminnot

	Kiertoilma	Tasainen lopputulos, mureus, kuivaus
	Ylä-/alalämpö	Perinteinen leivonnaisten paistaminen
	Pizza-toiminto	Pizzan valmistaminen
	Matalalämpö	Murea paisti
	Alalämpö	Kakkujen paistaminen
	Pakasteet	Puolivalmisteet (esim. ranskalaiset perunat)
	Grilli	Grillaaminen, paahtaminen
	Pikagrillaus	Isojen annosten grillaukseen, paahtamiseen
	Tehogrillaus	Lihan paistaminen, ruskistus

Erityistoiminnot



**Leivän
paistaminen**
Gratinointi

 **Taikinan nostatus**  **Säilöntä**

Lämpimänä pito

 **Lautasten
lämmitys**

 **Kuivaus**

 **Sulatus**

Mikroaaltouuniin soveltuvat keittoastiat ja materiaalit

Käytä mikroaaltouunissa ainoastaan siihen soveltuvia keittoastioita ja materiaaleja. Käytä alla olevaa taulukkoa viitteenä.

Tarkista keittoastian/materiaalin määrätykset ennen käyttöä.

Keittoastia/materiaali	Mikroaaltotoiminto		Mikroaaltouunin yhdistelmätoiminto
	Pakasteiden sulatus	Lämmitys, Kypsentäminen	
Uunin kestävä lasi ja posliini, ei metalliosia, esim. kuumuutta kestävä lasi	✓	✓	✓
Uuniin sopimaton lasi ja posliini ilman hopeisia, kultaisia, platina- tai muita metallikoristeita	✓	X	X
Lasi ja lasikeraaminen uunin/sulatukseen kestävä materiaali	✓	✓	✓
Keraamiset ja saviastiat ilman kvartsi- tai metalliosia tai metalleja sisältäviä lasitteita	✓	✓	X
Keraamiset, posliini- ja saviastiat, joissa on lasittamaton pohja tai pieniä reikiä (esim. kahvoissa)	X	X	X
Kuumuutta kestävä muovi enintään 200 °C	✓	✓	X
Kartonki, paperi	✓	X	X
Kelmu	✓	X	X
Paistokelmu mikroaaltouuniturvallisella sulkimella	✓	✓	X
Paistoastiat jotka on valmistettu metallista, esim. emali, valurauta	X	X	✓
Paistovuokat, mustalakatut tai silikonipinnoitetut	X	X	✓
Paistolevy	X	X	X
Paistoritilä	X	X	✓
Mikroaaltouunin alustan lasilevy	✓	✓	X

Keittoastia/materiaali	Mikroaaltotoiminto		Mikroaaltouunin yhdistelmätoiminto
	Pakasteiden sulatus	Lämmitys, Kypsentaminen	
Mikroaaltouuniin tarkoitettut keittoastiat, esim. ruskistuspannu	X	✓	X

Vianmääritys

Jos laitteessasi on ongelmia, tarkista luku "Vianmääritys" käyttöoppaan täydestä

versiosta, joka on saatavilla osoitteessa: www.ikea.com.

Tekniset tiedot

Mitat (sisä)	Leveys Korkeus Syvyys	480 mm 217 mm 411 mm
Käytettävissä olevat tilat	43 litraa	
Leivinpellin pinta-ala	1424 cm ²	
Ylälämpövastus	1900 W	
Alalämpövastus	1000 W	
Grilli	1900 W	
Rengas	1650 W	
Kokonaisluokitus	3000 W	
Jännite	220 - 240 V	
Taajuus	50 Hz	
Toimintojen lukumäärä	17	

Περιγραφή προϊόντος

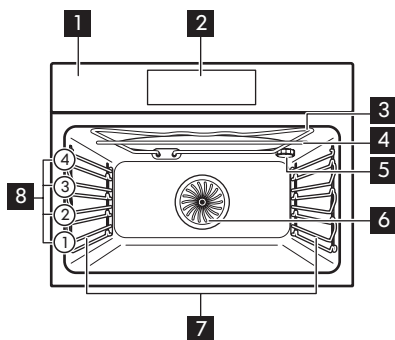

- 1** Πίνακας χειριστηρίων
- 2** Ηλεκτρονικός προγραμματιστής
- 3** Γκριλ
- 4** Γεννήτρια μικροκυμάτων
- 5** Λαμπτήρας
- 6** Ανεμιστήρας
- 7** Στήριξη σχάρας, αφαιρούμενη
- 8** Θέσεις σχάρας

Πίνακας Χειριστηρίων

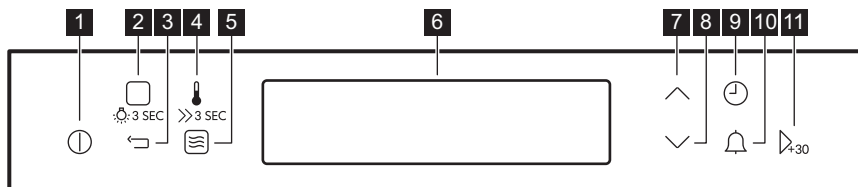





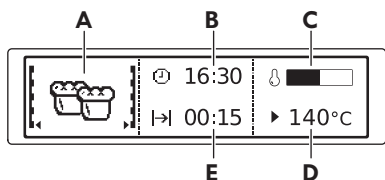





- 1** Ενεργοποίηση / Απενεργοποίηση
- 2** Προγράμματα / Μαγείρεμα Με Βοήθεια / Λυχνία
- 3** Πλήκτρο Πίσω
- 4** Θερμοκρασία / Ταχεία προθέρμανση
- 5** Λειτουργία μικροκυμάτων
- 6** Οθόνη
- 7** Πλήκτρο κύλισης προς τα πάνω
- 8** Πλήκτρο κύλισης προς τα κάτω
- 9** Ώρα / Περισσότερες λειτουργίες
- 10** Χρονομετρητής
- 11** OK / Γρήγορη έναρξη μικροκυμάτων

Οθόνη











- A.** Πρόγραμμα ή λειτουργία Μικροκυμάτων
- B.** Ώρα
- C.** Ένδειξη προθέρμανσης.
- D.** Θερμοκρασία ή ισχύς του φούρνου μικροκυμάτων
- E.** Διάρκεια ή τέλος μιας λειτουργίας









Άλλες ενδείξεις της οθόνης:

Σύμβολο	Λειτουργία
	Η λειτουργία είναι ενεργοποιημένη.
	Εμφανίζει την τρέχουσα ώρα.
	Εμφανίζει τον απαραίτητο χρόνο για το μαγείρεμα.
	Εμφανίζει τη διάρκεια μαγειρέματος.
	Εμφανίζει τη θερμοκρασία.
	Εμφανίζει πότε ολοκληρώνεται ο ρυθμισμένος χρόνος μαγειρέματος. Πιέστε το \vee και το \wedge ταυτόχρονα για να μηδενίσετε τον χρόνο.
	Υποδεικνύει το επίπεδο θερμότητας στον φούρνο.
	Η Ταχεία προθέρμανση είναι ενεργοποιημένη.
	Εμφανίζει ότι η λειτουργία Αυτομ. Προγρ. Βάρους είναι ενεργοποιημένη ή ότι μπορείτε να αλλάξετε τη ρύθμιση βάρους.
	Η λειτουργία Heat + hold είναι ενεργοποιημένη.

Προγράμματα

	Θερμός Αέρας	Ομοιόμορφο ψήσιμο, τρυφεράδα, ξήρανση
	Πάνω/Κάτω Θέρμανση	Παραδοσιακό ψήσιμο
	Λειτουργία Πίτσα	Ψήσιμο πίτσας
	Χαμηλή Θερμοκρασία	Για τρυφερά ψητά
	Κάτω Θέρμανση	Ψήσιμο κέικ
	Κατεψυγμένα τρόφιμα	Για πρόχειρο φαγητό (π.χ. τηγανιτές πατάτες)
	Γκριλ	Ψήσιμο στο γκριλ, φρυγάνισμα
	Γρήγορο Γκριλ	Ψήσιμο μεγάλων μερίδων στο γκριλ, φρυγάνισμα
	Γκριλ με Θερμό Αέρα	Ψήσιμο κρέατος, ρόδισμα

Ειδικά Προγράμματα

	Ψήσιμο Ψωμιού		Φούσκωμα ζύμης		Διατήρηση		Διατήρηση
	Ογκρατέν		Ζέσταμα πιάτων		Αποξήρανση		Απόψυξη
							Διατήρηση Θερμότητας

Κατάλληλα μαγειρικά σκεύη και υλικά για μικροκύματα

Για τα μικροκύματα, χρησιμοποιείτε μόνο τα κατάλληλα μαγειρικά σκεύη και υλικά. Χρησιμοποιήστε τον ακόλουθο πίνακα για οδηγό.

Ελέγξτε τις προδιαγραφές του μαγειρικού σκεύους / υλικού πριν από τη χρήση.

Μαγειρικά σκεύη / Υλικό	Λειτουργία μικροκυμάτων		Συνδυαστική Λειτουργία Μικροκυμάτων
	Απόψυξη	Ζέσταμα, Μαγείρεμα	
Πυρίμαχο γυαλί και πορσελάνη χωρίς μεταλλικά εξαρτήματα, π.χ. γυαλί ανθεκτικό στη θερμότητα	✓	✓	✓
Μη πυρίμαχο γυαλί και πορσελάνη χωρίς διακόσμηση από ασήμι, χρυσό, πλατίνα ή άλλο μέταλλο	✓	✗	✗
Γυαλί και κεραμικό γυαλί από πυρίμαχο υλικό / υλικό ανθεκτικό στο ψύχος	✓	✓	✓
Κεραμικά και πήλινα χωρίς τμήματα χαλαζία ή μετάλλου και σμάλτα που περιέχουν μέταλλα	✓	✓	✗
Κεραμικά, πορσελάνη και πήλινα μαγειρικά σκεύη χωρίς επιστρωμένο κάτω μέρος ή με μικρές οπές, π.χ. στις λαβές	✗	✗	✗
Πλαστικά ανθεκτικά στη θερμότητα έως 200 °C	✓	✓	✗
Χαρτόνι, χαρτί	✓	✗	✗
Πλαστική μεμβράνη	✓	✗	✗
Μεμβράνη μαγειρέματος με σφράγιση κατάλληλη για φούρνους μικροκυμάτων	✓	✓	✗
Ψήσιμο πιάτων από μέταλλο, π.χ. εμαγιέ, χυτοσίδηρο	✗	✗	✓
Φόρμες ψησίματος, μαύρη λάκα ή επικαλυμμένη σιλικόνη	✗	✗	✓
Ταψί ψησίματος	✗	✗	✗
Μεταλλική σχάρα	✗	✗	✓

Μαγειρικά σκεύη / Υλικό	Λειτουργία μικροκυμάτων		Συνδυαστική Λειτουργία Μικροκυμάτων
	Απόψυξη	Ζέσταμα, Μαγείρεμα	
Γυάλινο πιάτο μικροκυμάτων	✓	✓	✗
Μαγειρικά σκεύη κατάλληλα για χρήση σε φούρνο μικροκυμάτων, π.χ. ταψί ροδίσματος	✗	✓	✗

Επίλυση προβλημάτων

Εάν αντιμετωπίσετε κάποιο πρόβλημα με τη συσκευή σας, ανατρέξτε στο κεφάλαιο «Αντιμετώπιση προβλημάτων» στην πλήρη

έκδοση του Εγχειριδίου Χρήστη που διατίθεται στη διεύθυνση: www.ikea.com.

Τεχνικά χαρακτηριστικά

Διαστάσεις (εσωτερικές)	Πλάτος Ύψος Βάθος	480 mm 217 mm 411 mm
Ωφέλιμος όγκος	43 l	
Περιοχή για το ταψί ψησίματος	1424 cm ²	
Πάνω αντίσταση	1900 W	
Κάτω αντίσταση	1000 W	
Γκριλ	1900 W	
Κυκλική αντίσταση	1650 W	
Συνολική κατανάλωση	3000 W	
Τάση	220 - 240 V	
Συχνότητα	50 Hz	
Αριθμός λειτουργιών	17	

Produkta apraksts

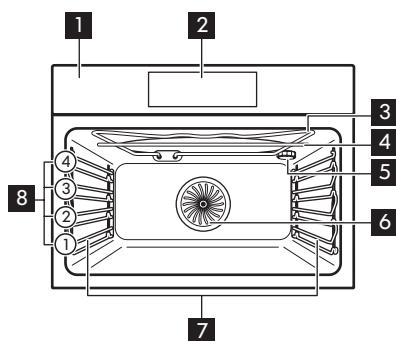

- 1** Vadības panelis
- 2** Elektroniskais programmētājs
- 3** Grils
- 4** Mikroviļņu krāsns ģenerators
- 5** Lampa
- 6** Ventilators
- 7** Plaukta atbalsts, izņemams
- 8** Plauktu līmeņi

Vadības panelis

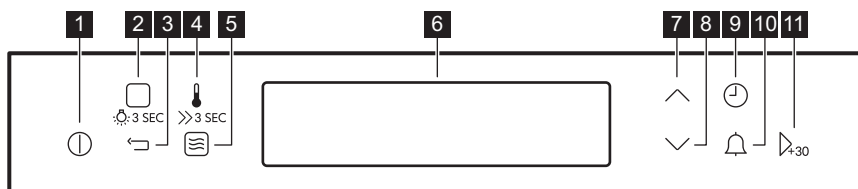





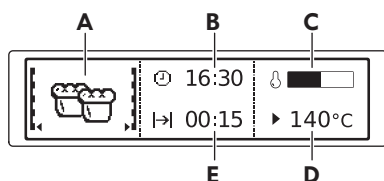





- 1** Ieslēgt/Izslēgt
- 2** Karsēšanas funkcijas / Gatavošanas Palīgs / Lampa
- 3** Atpakaļ taustiņš
- 4** Temperatūra / Ātrā uzsilšana
- 5** Mikroviļņu krāsns funkcija
- 6** Displejs
- 7** Taustiņš uz augšu
- 8** Taustiņš uz leju
- 9** Laiks / vairāk funkciju
- 10** Laika atgādinājums
- 11** LABI / Mikroviļņu krāsns ātrais starts

Displejs











- A.** Karsēšanas funkcija vai mikroviļņu funkcija
- B.** Diennakts laiks
- C.** Uzkarsēšanas indikators
- D.** Temperatūra vai mikroviļņu jauda
- E.** Funkcijas darb. laiks vai beigu laiks









Citi indikatori displejā:

Simbols	Funkcija
	Funkcija ir ieslēgta.
	Rāda pašreizējo laiku.
	Rāda gatavošanai nepieciešamo laiku.
	Rāda gatavošanas ilgumu.
	Rāda temperatūru.
	Kad beidzas iestatītais gatavošanas laiks. Lai atiestatītu laiku, vienlaikus nospiediet \vee un \wedge .
	Norāda cepeškrāsns karsēšanas līmeni.
	Ieslēgta ātrā uzsilšana.
	Rāda, ka ir ieslēgta automātiskā svara funkcija vai ka varat mainīt svara iestatījumu.
	Ieslēgta funkcija Karstums + pauze.

Karsēšanas funkcijas

	Karsēšana ar ventilatoru	Vienmērīga cepšana, saudzīgums, kaltēšana
	Tradicionālā gatavošana	Tradicionāla cepšana
	Picas funkcija	Picas cepšana
	Lēnā gatavošana	Maigiem cepešiem
	Apakškarsēšana	Kūku cepšana
	Saldēta pārtika	Pusfabrikātiem (piem., kartupeļiem frī)
	Grils	Grilēšana, grauздēšana
	Ātrā grilēšana	Lielu porciju grilēšanai, apcepšanai
	Infratermiskā grilēšana	Gaļas cepšana, apbrūnināšana

Īpašās funkcijas

	Maizes cepšana		Mīklas raudzēšana		Konservēšana		Siltuma uzturēšana
	Sacepums		Trauku uzsildīšana		Dehidrācija		Atkausēšana

Mikroviļņiem piemēroti ēdiena gatavošanas trauki un materiāli

Gatavošanai ar mikroviļņiem izmantojiet tikai piemērotus ēdiena gatavošanas traukus un materiālus. Atsaucei izmantojiet tālāk sniegtās tabulas.

Pirms lietošanas pārbaudiet ēdiena gatavošanas trauku/materiāla parametrus.

Ēdiena gatavošanas trauku materiāls	Mikroviļņu krāsns funkcija		Mikroviļņu kombinētā funkcija
	Atkausēšana	Karsēšana Ēdiena gatavošana	
Ugunsizturīgs stikls un porcelāns bez metāla detaļām, piem., karstumizturīgs stikls	✓	✓	✓
Ugunsneizturīgs stikls un porcelāns bez sudraba, zelta, platīna vai metāla rotājumiem	✓	x	x
Stikls un stikla keramika, kas izgatavota no ugunsizturīga / sala izturīga materiāla	✓	✓	✓
Keramikas un māla ēdiena gatavošanas trauki bez kvarca vai metāla komponentiem vai metālu saturošas glazūras	✓	✓	x
Keramika, porcelāns un māls ar neglazētu apakšu vai ar maziem caurumiem, piemēram, uz rokturiem	x	x	x
Karstumizturīgs plastikāts līdz 200 °C	✓	✓	x
Kartons, papīrs	✓	x	x
Pārtikas plēve	✓	x	x
Cepamā plēve ar mikroviļņu drošu aizslēgu	✓	✓	x
Cepšana ar metāla traukiem, piem. emaljētiem, čuguna	x	x	✓
Cepšanas formas ar spīdīgu vai silikona pārklājumu	x	x	✓
Cepamā Paplāte	x	x	x

Ēdiena gatavošanas trauku materiāls	Mikroviļņu krāsns funkcija		Mikroviļņu kombinētā funkcija
	Atkausēšana	Karsēšana Ēdiena gatavošana	
Restots plaukts	X	X	✓
Mikroviļņu krāsns apakšējais stikla šķīvis	✓	✓	X
Ēdiena gatavošanas trauki mikroviļņu izmantošanai, piemēram, apcepšanas panna	X	✓	X

Traucējummeklēšana

Ja jums rodas problēma ar jūsu ierīci, skatiet informāciju "Traucējummeklēšana" Lietotāja

instrukcijas pilnajā versijā, kas pieejama: www.ikea.com.

Tehniskie dati

Izmēri (iekšējie)	Platums Augstums Dziļums	480 mm 217 mm 411 mm
Izmantojamie apjomi	43 l	
Cepamās paplātes platība	1424 cm ²	
Augšējais sildelements	1900 W	
Apakšējais sildelements	1000 W	
Grils	1900 W	
Zvans	1650 W	
Kopējais vērtējums	3000 W	
Spriegums	220 - 240 V	
Frekvence	50 Hz	
Vairākas funkcijas	17	

Gaminio aprašymas

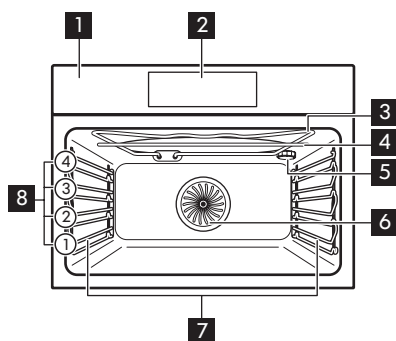

- 1** Valdymo skydelis
- 2** Elektroninis valdymo pultas
- 3** Grilis
- 4** Mikrobangų generatorius
- 5** Lemputė
- 6** Ventiliatorius
- 7** Lentynos atrama, išimama
- 8** Vietos lentynoje

Valdymo skydelis

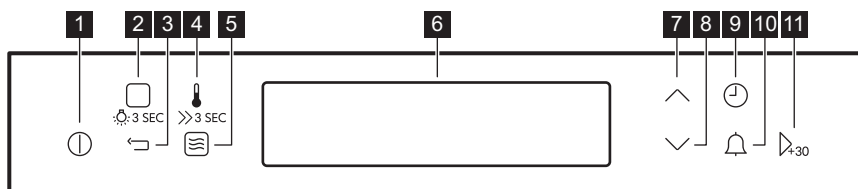





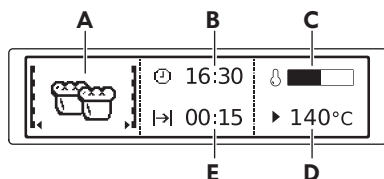

- 1** ĮJUNGTI / IŠJUNGTI
- 2** Kaitinimo funkcijos / Kepimo Vadovas / apšvietimas
- 3** Grįžimo mygtukas
- 4** Temperatūra / Greitasis įkaitinimas
- 5** Mikrobangų funkcija
- 6** Valdymo skydelis
- 7** Mygtukas „Aukštyn“
- 8** Mygtukas „Žemyn“
- 9** Laikas / daugiau funkcijų
- 10** Laikmatis
- 11** Gerai / greitasis mikrobangų krosnelės įjungimas

Valdymo skydelis











- A.** Kaitinimo arba mikrobangų funkcija
- B.** Paros laikas
- C.** Kaitinimo indikatorius
- D.** Temperatūra arba mikrobangų galia
- E.** Funkcijos trukmė ir pabaiga

Kiti ekrano indikatoriai:

Simbolis	Funkcija
	Funkcija įjungta.
	Rodo esamą laiką.
	Rodo maistui pagaminti reikalingą laiką.
	Rodo maisto ruošimo trukmę.
	Rodo temperatūrą.
	Rodo, kai ruošimo laikas baigiasi. Norėdami atkurti laiką, vienu metu paspauskite \checkmark ir \wedge .
	Nurodo kaitros lygį orkaitėje.
	Greitas įkaitinimas įjungtas.
	Rodo įjungtą automatinę svorio nustatymo funkciją arba galimybę pakeisti svorio nuostatą
	Funkcija „Kaitinti + palaikyti“ įjungta.

Kaitinimo funkcijos

	Karšto oro srautas	Tolygus kepimas, minkštumas, džiovinimas
	Įprastas kaitinimas	Tradicinis kepimas
	Picos funkcija	Picos kepimas
	Lėtas ruošimas	Minkštiems kepsniams ruošti
	Apatinis kaitinimas	Pyragų kepimas
	Šaldytas maistas	Pusfabrikačiams ruošti (pvz., gruzdintoms bulvytėms)
	Grilis	Kepti ant grotelių, skrudinti
	Greitasis kepimas grilyje	Didelių porcijų kepimas ir skrudinimas
	Turbo grilis	Mėsos kepimas, skrudinimas

Specialiosios

	Duonos kepimas		Tešlos kildinimas		Konservavimas		Šilumos palaikymas
	Apkepas "Au Gratin"		Lėkščių pašildymas		Džiovinimas		Atitirpinimas

Tinkami mikrobangų krosnelei indai ir medžiagos

Gaminimui mikrobangomis naudokite tik tinkamus prikaistuvius ir medžiagas. Vadovaukitės toliau pateikta lentele.

Prieš naudodami patikrinkite prikaistuvių / medžiagų specifikaciją.

Indų tipai ir jų medžiagos	Mikrobangų funkcija		Mikrobangų kombi- nuotoji funkcija,
	Atšildymas	Kaitinimas, Maisto gamini- mas	
Stiklas ir porcelianas, kurį galima nau- doti orkaitėje be jokių metalinių dalių, pvz., karščiui atsparus stiklas	✓	✓	✓
Karščiui neatsparus stiklas ir porcelia- nas be sidabro, aukso, platinos ar kitų metalo papuošimų	✓	x	x
Stiklas ir stiklo keramika, pagaminta iš orkaitėje tinkamos naudoti / šalčiui at- sparios medžiagos	✓	✓	✓
Keramikos ir moliniai indai be kvarco, metalo dalių ar glazūros, kurioje būtų metalo	✓	✓	x
Keramika, porcelianas ir moliniai indai su neglazūruota apačia arba mažomis skylutėmis, pvz., rankenose	x	x	x
Iki 200 °C karščiui atsparus plastikas	✓	✓	x
Kartonas, popierius	✓	x	x
Maistinė plėvelė	✓	x	x
Kepimo plėvelė su spaustuku, saugiu naudoti mikrobangų krosnelėje	✓	✓	x
Patiekalų skrudinimas metaliniame in- de, pvz. emaliuotame, ketaus	x	x	✓
Kepimo skardos, padengtos juodu la- ku arba silikonu	x	x	✓
Kepimo padėklas	x	x	x
Vielinė lentynėlė	x	x	✓

Indų tipai ir jų medžiagos	Mikrobangų funkcija		Mikrobangų kombi- nuotoji funkcija,
	Atšildymas	Kaitinimas, Maisto gamini- mas	
Stiklinė mikrobangų krosnelės apatinė lėkštė	✓	✓	X
Prikaistuvius mikrobangų krosnei, pvz., skrudinimo indas	X	✓	X

Trikčių diagnostika

Kilus nesklaidumams perskaitykite naudojimo instrukcijos skyrių „Trikčių šalinimas“; instrukciją rasite: www.ikea.com.

Techniniai duomenys

Matmenys (vidiniai)	Plotis Aukštis Gylis	480 mm 217 mm 411 mm
Panaudojami tūriai	43 l	
Kepimo padėklo sritis	1424 cm ²	
Viršutinis šildymo elementas	1900 W	
Apatinis šildymo elementas	1000 W	
Grilis	1900 W	
Žiedas	1650 W	
Bendras vertinimas	3000 W	
Įtampa	220 - 240 V	
Dažnis	50 Hz	
Funkcijų skaičius	17	

Opis produktu

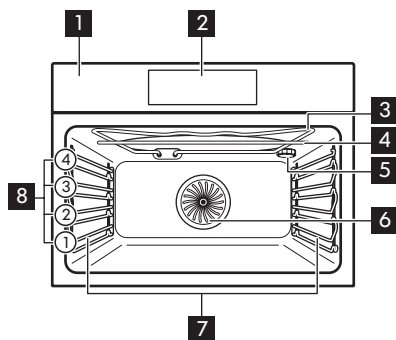

- 1** Panel sterowania
- 2** Sterowanie elektroniczne
- 3** Grill
- 4** Generator mikrofal
- 5** Lampa
- 6** Wentylator
- 7** Prowadnice blach, wyjmowane
- 8** Poziomy umieszczenia potraw

Panel sterowania

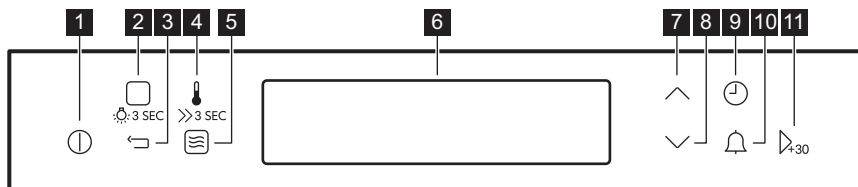





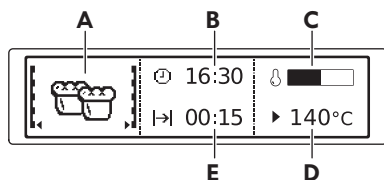





- 1** WŁ. / WYŁ.
- 2** Funkcje pieczenia / Gotowanie wspomagane / Lampa
- 3** Przycisk Powrót
- 4** Temperatura / Szybkie nagrzewanie
- 5** Funkcja kuchenki mikrofalowej
- 6** Wyświetlacz
- 7** Przycisk strzałki w górę
- 8** Przycisk strzałki dół
- 9** Czas / Więcej funkcji
- 10** Minutnik
- 11** OK / Szybkie włączenie kuchenki mikrofalowej

Ekran











- A.** Funkcja pieczenia lub funkcja kuchenki mikrofalowej
- B.** Aktualna godzina
- C.** Wskaźnik podgrzewania
- D.** Temperatura lub moc mikrofal
- E.** Czas trwania i czas zakończenia działania funkcji









Pozostałe wskaźniki wyświetlacza:

Symbol	Funkcja
	Funkcja jest włączona.
	Pokazuje bieżącą godzinę.
	Wyświetla niezbędny czas pieczenia.
	Pokazuje czas pieczenia.
	Pokazuje temperaturę.
	Pokazuje, kiedy kończy się ustawiony czas gotowania. Nacisnąć równocześnie \vee i \wedge , aby zresetować godzinę.
	Wskazuje poziom ciepła w piekarniku.
	Szybkie nagrzewanie jest włączone.
	Pokazuje, że funkcja Automatyka wagowa jest włączona lub że można zmienić ustawienie wagi
	Włączona jest funkcja Pieczenie+utrzym. temp.

Funkcje pieczenia

	Termoobieg	Równomierne pieczenie, uzyskanie delikatnej konsystencji, suszenie
	Pieczenie tradycyjne	Tradycyjne pieczenie
	Funkcja Pizza	Pieczenie pizzy
	Wolne gotowanie	Do delikatnych pieczeni
	Grzałka dolna	Pieczenie ciast
	Potrawy mrożone	Do żywności gotowej (np. frytek)
	Grill	Grillowanie, opiekanie tostów
	Szybkie grillowanie	Grillowanie dużych porcji, opiekanie tostów
	Turbo grill	Pieczenie mięsa, przyrumienianie

Specjalne

	Pieczenie chleba		Wyrastanie ciasta		Pasteryzowanie		Odstawić w ciepłe miejsce
	Zapiekaniki		Podgrzewanie talerzy		Suszenie		Rozmrażanie

Odpowiednie naczynia i materiały do kuchenki mikrofalowej

Do gotowania w kuchenke mikrofalowej używać tylko materiałów i naczyń do tego przeznaczonych. Patrz poniższa tabela.

Przed użyciem należy sprawdzić naczynie lub właściwości materiału, z którego wykonane jest naczynie.

Naczynia/materiał	Funkcja kuchenki mikrofalowej		Funkcja kuchenki mikrofalowej w trybie łączonym,
	Rozmrażanie	Podgrzewanie, Gotowanie	
Szkoło i porcelana odporne na wysoką temperaturę, bez metalowych elementów, np. szkło żaroodporne	✓	✓	✓
Szkoło i porcelana nieodporne na wysoką temperaturę bez srebrnych, złotych, platynowych lub innych metalowych elementów	✓	X	X
Szkoło i szkło ceramiczne z materiałów odpornych na wysoką i niską temperaturę	✓	✓	✓
Materiały ceramiczne bez kwarcowych i metalowych elementów oraz szkliska z zawartością metalu	✓	✓	X
Materiały ceramiczne, porcelana i fajans z niepowlekanym dnem lub z małymi otworami np. w uchwytach	X	X	X
Tworzywo sztuczne odporne na wysoką temperaturę do 200°C	✓	✓	X
Karton, papier	✓	X	X
Folia	✓	X	X
Folia do pieczenia z zamknięciem nadającym się do kuchenek mikrofalowych	✓	✓	X
Naczynia do pieczenia z metalu, np. emaliowane, żeliwne	X	X	✓
Formy do pieczenia lakierowane na czarno lub z powłoką silikonową	X	X	✓

Naczynia/materiał	Funkcja kuchenki mikrofalowej		Funkcja kuchenki mikrofalowej w trybie łączonym,
	Rozmrażanie	Podgrzewanie, Gotowanie	
Błacha do pieczenia ciasta	X	X	X
Ruszt	X	X	✓
Szklana dolna płyta kuchenki mikrofalowej	✓	✓	X
Naczynia przeznaczone do kuchenek mikrofalowych, np. talerz Crisp	X	✓	X

Rozwiązywanie problemów

Jeśli wystąpi problem z urządzeniem należy zapoznać się z rozdziałem „Rozwiązywanie

problemów” w pełnej wersji instrukcji obsługi dostępnej na stronie: www.ikea.com.

Dane techniczne

Wymiary (wewnętrzne)	Szerokość Wysokość Głębokość	480 mm 217 mm 411 mm
Pojemność użytkowa	43 l	
Obszar blachy do pieczenia ciasta	1424 cm ²	
Górna grzałka	1900 W	
Dolna grzałka	1000 W	
Grill	1900 W	
Rozszerzenie pola grzejnego	1650 W	
Łączna moc znamionowa	3000 W	
Napięcie	220 - 240 V	
Częstotliwość	50 Hz	
Liczba funkcji	17	

Popis produktu

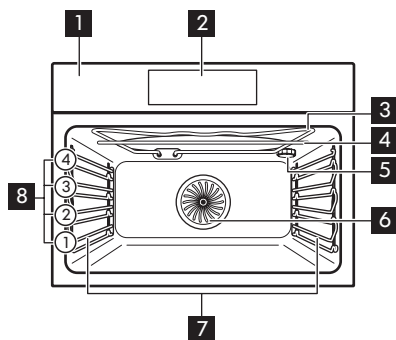

- 1** Ovládací panel
- 2** Elektronický programátor
- 3** Gril
- 4** Generátor mikrovlnnej rúry
- 5** Osvetlenie
- 6** Ventilátor
- 7** Zasúvacia lišta, odstrániteľná
- 8** Úrovne roštu v rúre

Ovládací panel

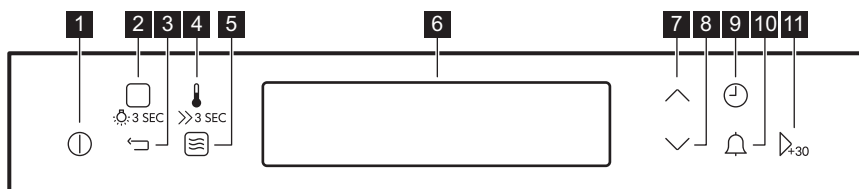





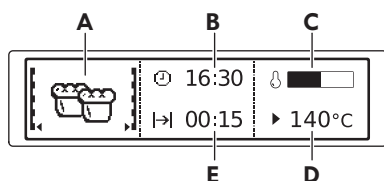





- 1** Zap./Vyp.
- 2** Funkcie ohrevu / Sprievodca Pečením / Osvetlenie
- 3** Tlačidlo Späť
- 4** Teplota / Rýchle zohrievanie
- 5** Funkcia mikrovlnnej rúry
- 6** Displej
- 7** Tlačidlo na posun nahor
- 8** Tlačidlo na posun nadol
- 9** Nastavenie času / Viac funkcií
- 10** Časomer
- 11** OK/rýchly štart mikrovlnnej rúry

Displej











- A.** Funkcia ohrevu alebo funkcia mikrovln
- B.** Presný čas
- C.** Ukazovateľ ohrevu
- D.** Teplota alebo výkon mikrovlnnej rúry
- E.** Doba trvania alebo skončenia funkcie









Iné ukazovatele na displeji:

Symbol	Funkcia
	Funkcia je zapnutá.
	Zobrazuje aktuálny čas.
	Zobrazuje čas potrebný na pečenie.
	Zobrazuje dobu trvania pečenia.
	Zobrazuje teplotu.
	Zobrazuje koniec nastaveného času pečenia. Ak chcete znovu nastaviť čas, stlačte súčasne \vee a \wedge .
	Indikuje úroveň ohrevu v rúre.
	Funkcia Rýchle zohrievanie je zapnutá.
	Zobrazuje, že je zapnutá funkcia Hmotnostný program alebo že môžete zmeniť nastavenie hmotnosti
	Funkcia Ohrev a uchovanie teploty je zapnutá.

Funkcie ohrevu

	Teplovzdušné pečenie	Rovnomerné pečenie, jemnosť, sušenie
	Tradičné pečenie	Tradičné pečenie
	Funkcia Pizza	Pečenie pizze
	Pomalé pečenie	Na jemné pečené mäso
	Dolný ohrev	Pečenie koláčov
	Mrazené pokrmy	Pre polotovary (napr. hranolčeky)
	Gril	Grilovanie, toastovanie
	Rýchly gril	Grilovanie veľkých porcií, opekanie
	Turbo grilovanie	Pečenie mäsa, zapekanie

Špeciálne

	Pečenie chleba		Kysnutie cesta		Zaváranie		Uchovať teplé
	Gratinované jedlá		Ohrev tanierov		Sušenie potravín		Rozmrazovanie

Kuchynský riad a materiály vhodné do mikrovlnnej rúry

Používajte iba kuchynský riad a materiály vhodné do mikrovlnnej rúry. Použite tabuľku nižšie ako referenciu.

Pred použitím skontrolujte technické údaje kuchynského riadu/materiálu.

Kuchynský riad/materiál	Funkcia mikrovlnnej rúry		Kombinovaná mikrovlnná funkcia,
	Rozmrazovanie	Ohrev, Varenie	
Sklo a porcelán vhodné na použitie v rúre bez kovových prvkov, napr. teplovzdorné sklo	✓	✓	✓
Sklo a porcelán nevhodné na použitie v rúre bez striebra, zlata, platiny alebo iných kovových ozdôb	✓	X	X
Sklo a sklokeramika vyrobené z materiálu vhodného na použitie v rúre/ mrazuvzdorného materiálu	✓	✓	✓
Keramický a hlinený riad bez kremeňových alebo kovových prvkov a glazúry, ktoré obsahujú kov	✓	✓	X
Kuchynský riad vyrobený z porcelánu, keramiky alebo hlíny, ktorý má neglazovaný spodok alebo drobné otvory, napr. na rukovätiach	X	X	X
Teplovzdorný plast až do 200 °C	✓	✓	X
Kartón, papier	✓	X	X
Potravinová fólia	✓	X	X
Fólia na pečenie s uzáverom vhodným pre mikrovlnné rúry	✓	✓	X
Nádoby na pečenie vyrobené z kovu, napr. smaltu, zliatiny	X	X	✓
Formy na pečenie, s čiernym lakom alebo silikónovou vrstvou	X	X	✓
Plech na pečenie	X	X	X
Drôtený rošt	X	X	✓
Spodný sklenený tanier mikrovlnnej rúry	✓	✓	X
Kuchynský riad vhodný do mikrovlnnej rúry, napr. zapekací pekáč	X	✓	X

Riešenie problémov

Ak sa vyskytne problém so spotrebičom, pozrite si kapitolu „Riešenie problémov“ v

plnej verzii návodu na používanie, ktorý je k dispozícii na: www.ikea.com.

Technické údaje

Rozmery (vnútorné)	Šírka Výška Hĺbka	480 mm 217 mm 411 mm
Použiteľné objemy	43 l	
Oblasť plechu na pečenie	1424 cm ²	
Horný ohrevný článok	1900 W	
Dolný ohrevný článok	1000 W	
Gril	1900 W	
Kruhové ohrevné teleso	1650 W	
Celkový príkon	3000 W	
Napätie	220 - 240 V	
Frekvencia	50 Hz	
Počet funkcií	17	

Produktbeskrivning

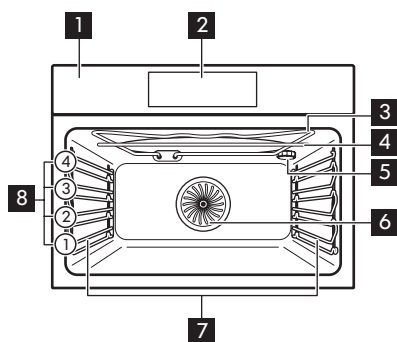

- 1** Kontrollpanel
- 2** Elektronisk programmeringsenhet
- 3** Grill
- 4** Mikrovågsgenerator
- 5** Lampa
- 6** Fläkt
- 7** Ugnsstegar, borttagbara
- 8** Hyllplaceringar

Kontrollpanel

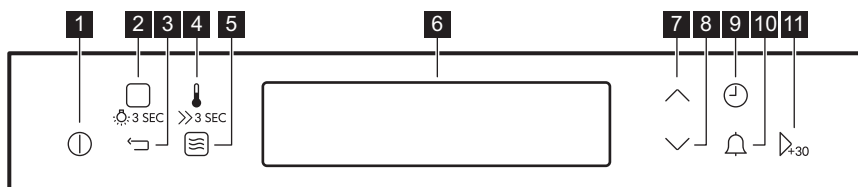





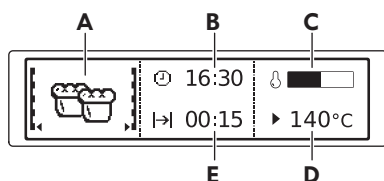





- 1** PÅ/AV
- 2** Tillagningsfunktioner /Tillagningshjälp/
Lampa
- 3** Tillbaka-tangent
- 4** Temperatur / Snabbuppvärmning
- 5** Mikrovågsgugn
- 6** Display
- 7** Uppåtknapp
- 8** Nedåtknapp
- 9** Funktionerna Tid/Mer
- 10** Signalur
- 11** OK / Mikrovågsgugn snabbstart

Display











- A.** Tillagningsfunktion eller mikrovågsgugn
- B.** Klockslag
- C.** Uppvärmningsindikator
- D.** Mikrovågsgugnens temperatur eller effekt
- E.** Funktionens tillagningstid och sluttid







Andra indikatorer på displayen:

Symbol	Funktion
	Funktionen är på.
	Visar aktuell tid.
	Visar den nödvändiga tillagningstiden.
	Visar tillagningstiden.
	Visar temperaturen.
	Visar när tillagningstiden avslutas. Tryck på \vee och \wedge samtidigt för att återställa tiden.
	Anger värmenivån i ugnen.
	Snabbuppvärmning är på.
	Visar att funktionen Automatisk vikt är aktiverad eller att du kan ändra viktinställningen
	Funktionen Heat + Hold är aktiverad.

Tillagningsfunktioner

	Varmluft	Jämn bakning, mörhet, torkning
	Över-/undervärme	Traditionell bakning
	Pizza/Paj	Pizza
	Långsam tillagning	För möra stekar
	Undervärme	Mjuka kakor
	Frost mat	För bekvämlighetsmat (t.ex. pommes frites)
	GRILL	Grilla, rosta
	Snabbgrillning	Grilla stora portioner, rosta
	Varmluftsgillning	Steka och bryna kött

Specialfunktioner

	Brödbakning		Jäsning av deg		Konservering		Varmhållning
	Gratinerung		Tallriksvärmning		Torkning		Upptining

Lämpliga kokkärl och material för mikrovågsugn

För mikrovågsugnen får man endast använda lämpliga kärl och material. Se tabellen nedan som referens.

Kontrollera kokkäret/
materialspekifikationerna före användning.

Kokkärl/material	Mikrovågsugn		Mikrovågsugnens kombifunktion
	Upptining	Uppvärmning, Tillagning	
Ugnsfast glas och porslin utan metall-delar, t.ex. värmebeständigt glas	✓	✓	✓
Ej ugnsfast glas och porslin utan de- kor av silver, guld, platina eller andra metaller	✓	x	x
Glas och vitrokeramik av ugnsfast/ fryståligt material	✓	✓	✓
Keramik och lergods utan kvarts eller metallkomponenter och glasyrer som innehåller metall	✓	✓	x
Keramik, porslin och lergods med og- laserad botten eller med små hål, t.ex. på handtagen	x	x	x
Värmebeständig plast upp till 200 °C	✓	✓	x
Kartong, papper	✓	x	x
Plastfolie	✓	x	x
Stekpåse med förslutning som är lämplig för mikrovågsugn	✓	✓	x
Stekkärl av metall, t.ex. emalj, gjutjärn	x	x	✓
Bakformar, svartlack eller silikonbe- lagd	x	x	✓
Bakplåt	x	x	x
Galler	x	x	✓
Glasplatta i mikrovågsugnens botten	✓	✓	x
Kokkärl för mikrovågsugn, t.ex. kris- platta	x	✓	x

Felsökning

Om du stöter på ett problem med din produkt, se kapitlet "Felsökning" i den fullständiga versionen av

användarhandboken som finns på:
www.ikea.com.

Tekniska data

Mått (invändigt)	Bredd Höjd Djup	480 mm 217 mm 411 mm
Användbara volymer	43 l	
Område på bakplåten	1424 cm ²	
Värmeelement för övervärme	1900 W	
Värmeelement för undervärme	1000 W	
GRILL	1900 W	
Ring	1650 W	
Totalmärkning	3000 W	
Märkspänning	220 - 240 V	
Frekvens	50 Hz	
Antal funktioner	17	



867371853-B-262023

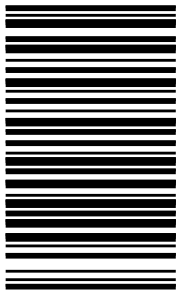

© Inter IKEA Systems B.V. 2023

21552

AA-2336032-3