

SKYTTA

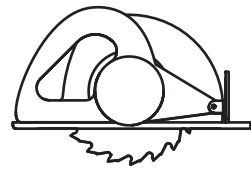

Design and Quality
IKEA of Sweden

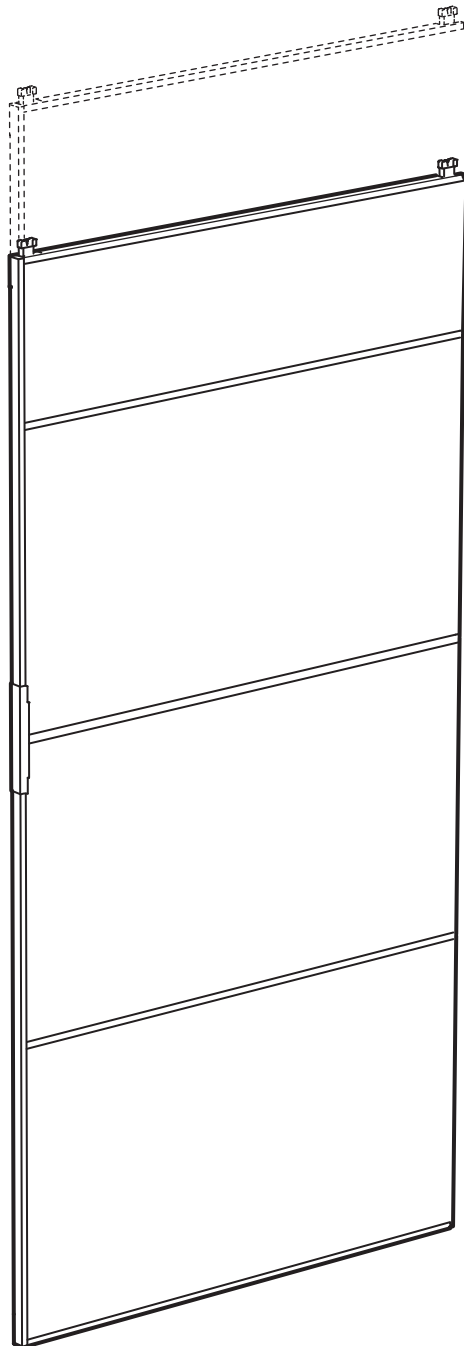
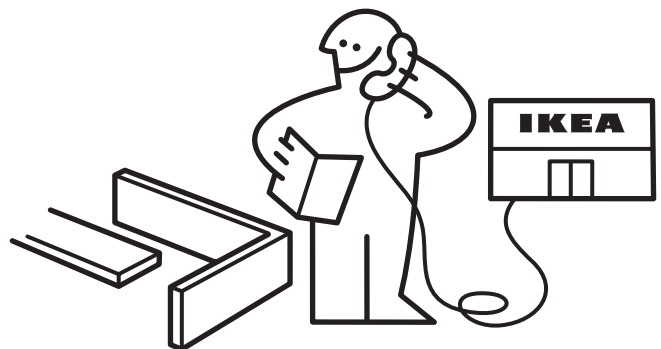
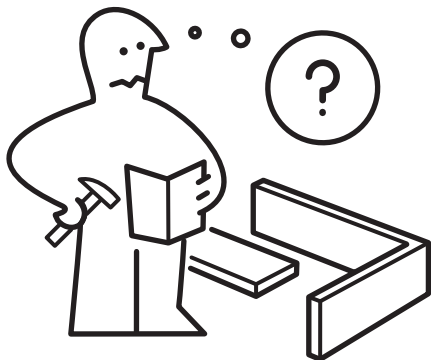
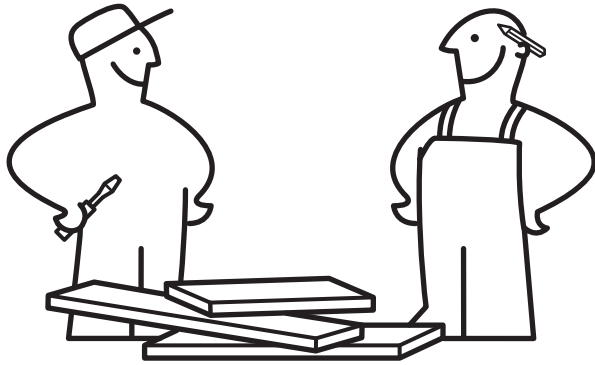
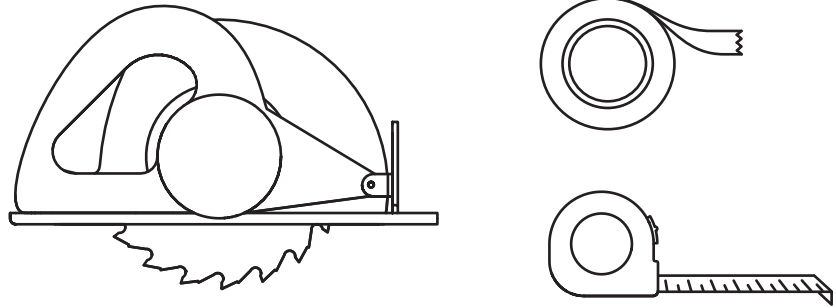
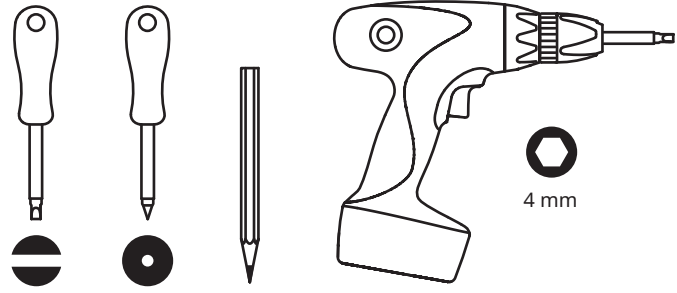
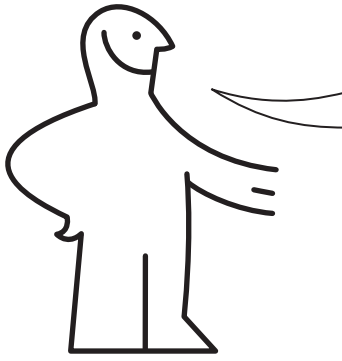

1

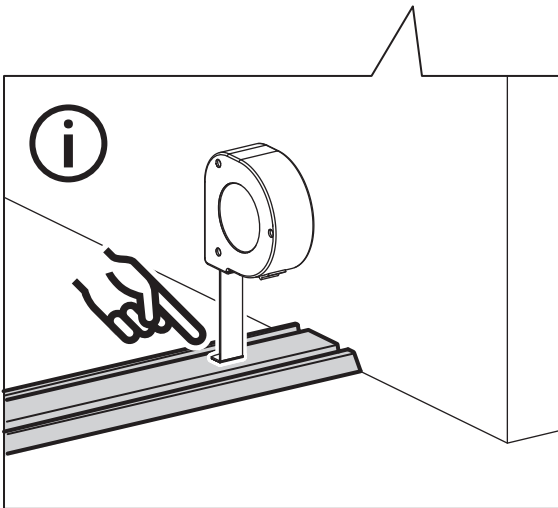
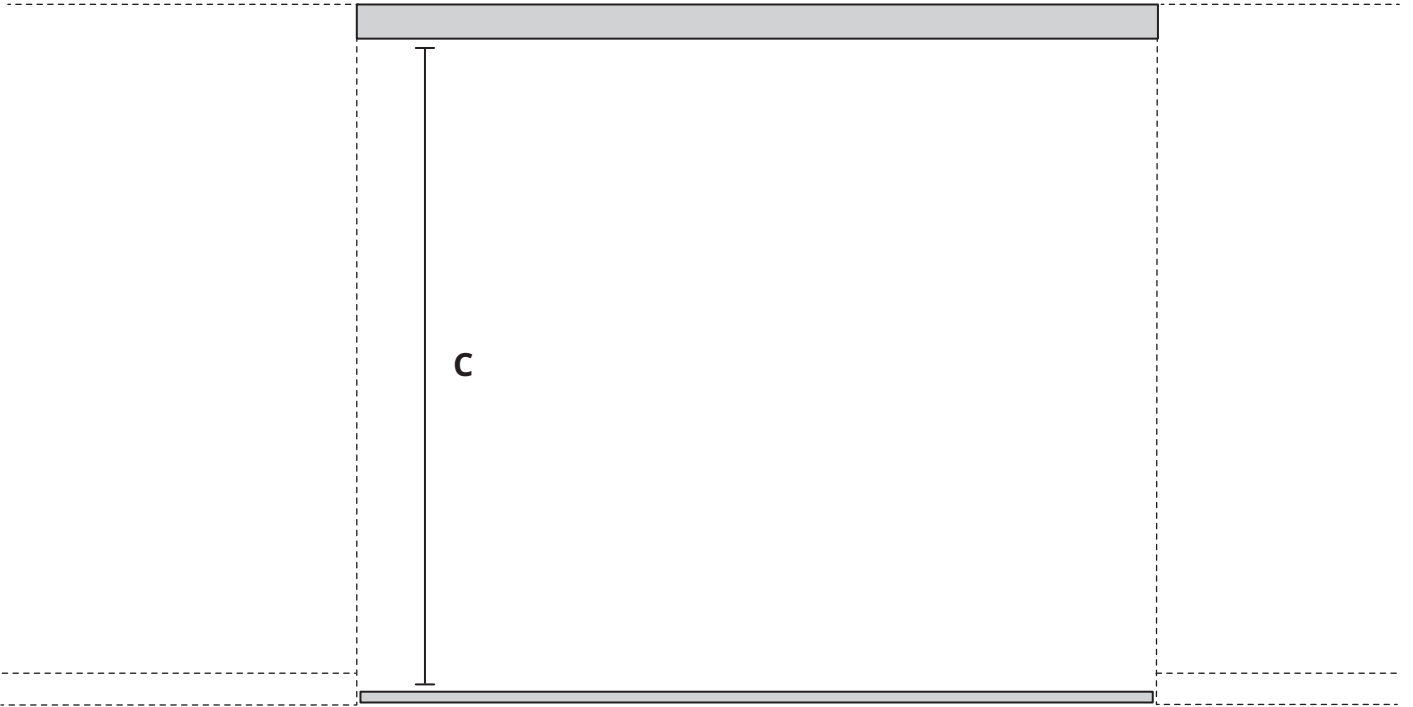
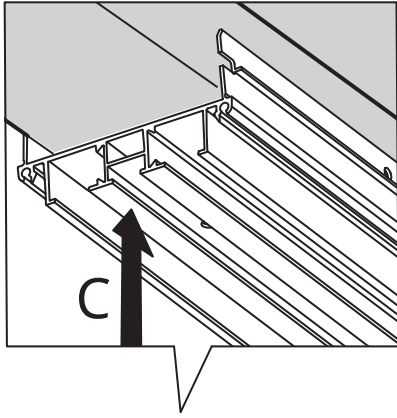

X = _____ mm

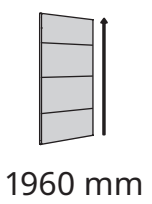
	$1987 \text{ mm} - C = X$
---	---------------------------

	$2339 \text{ mm} - C = X$
---	---------------------------

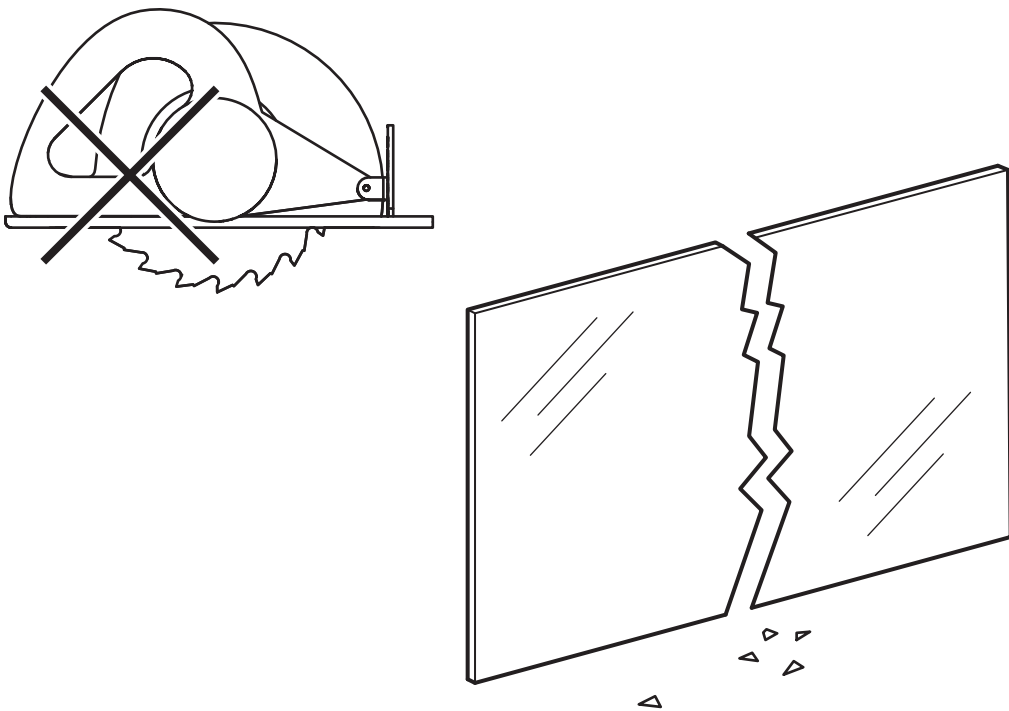
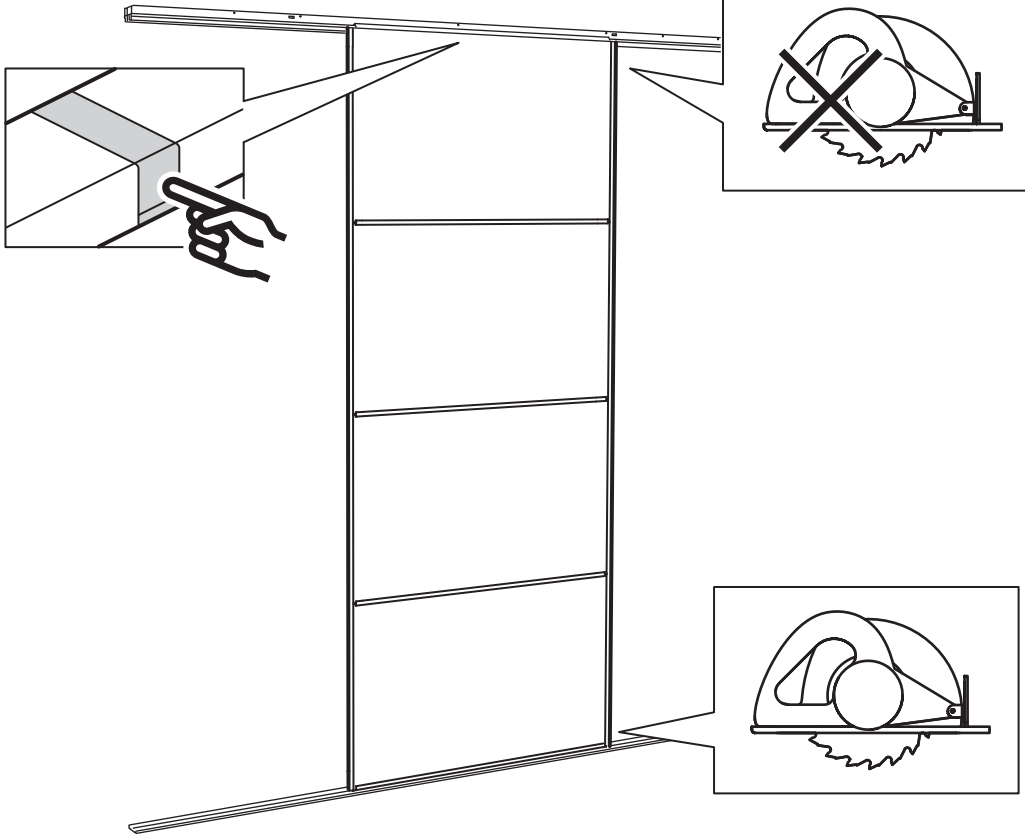

2

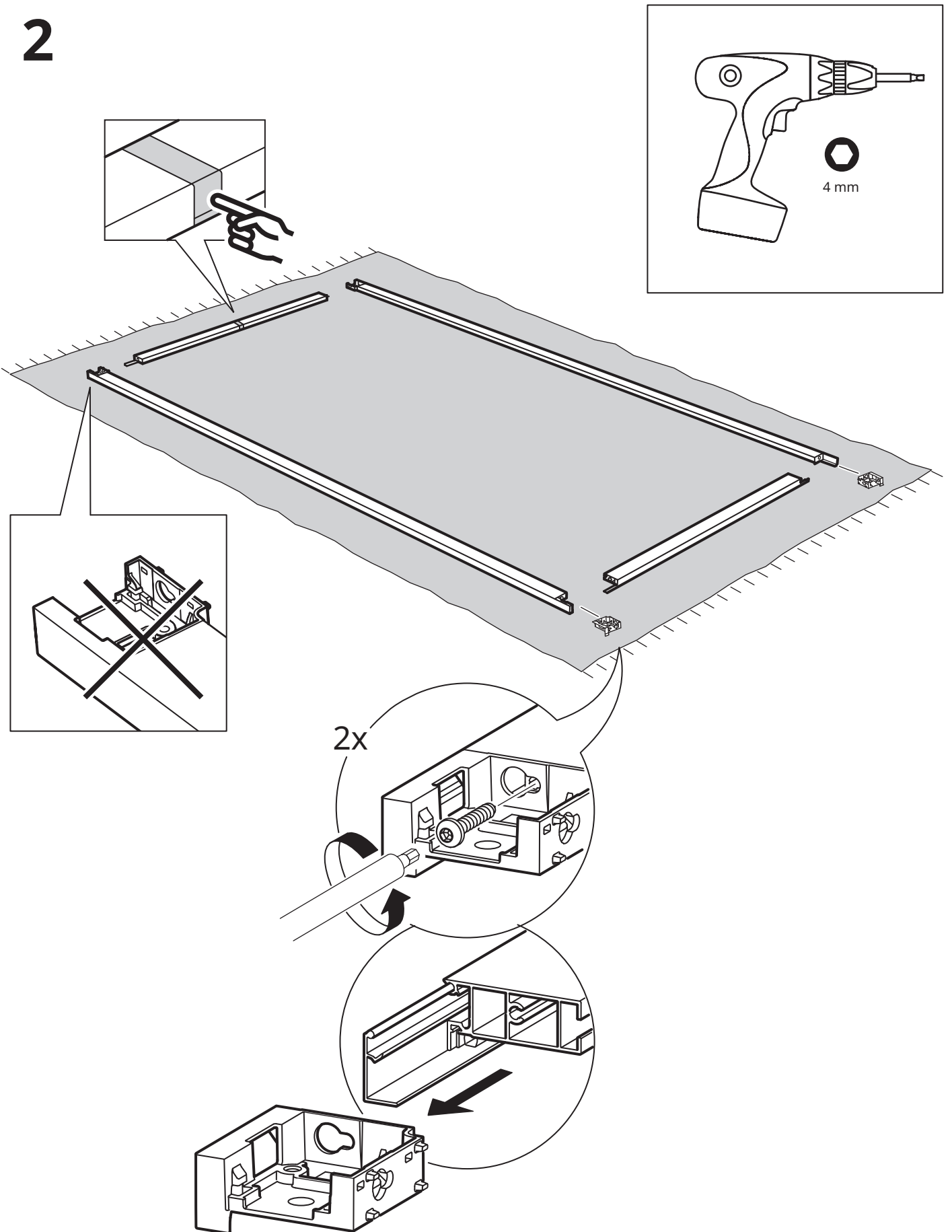

3

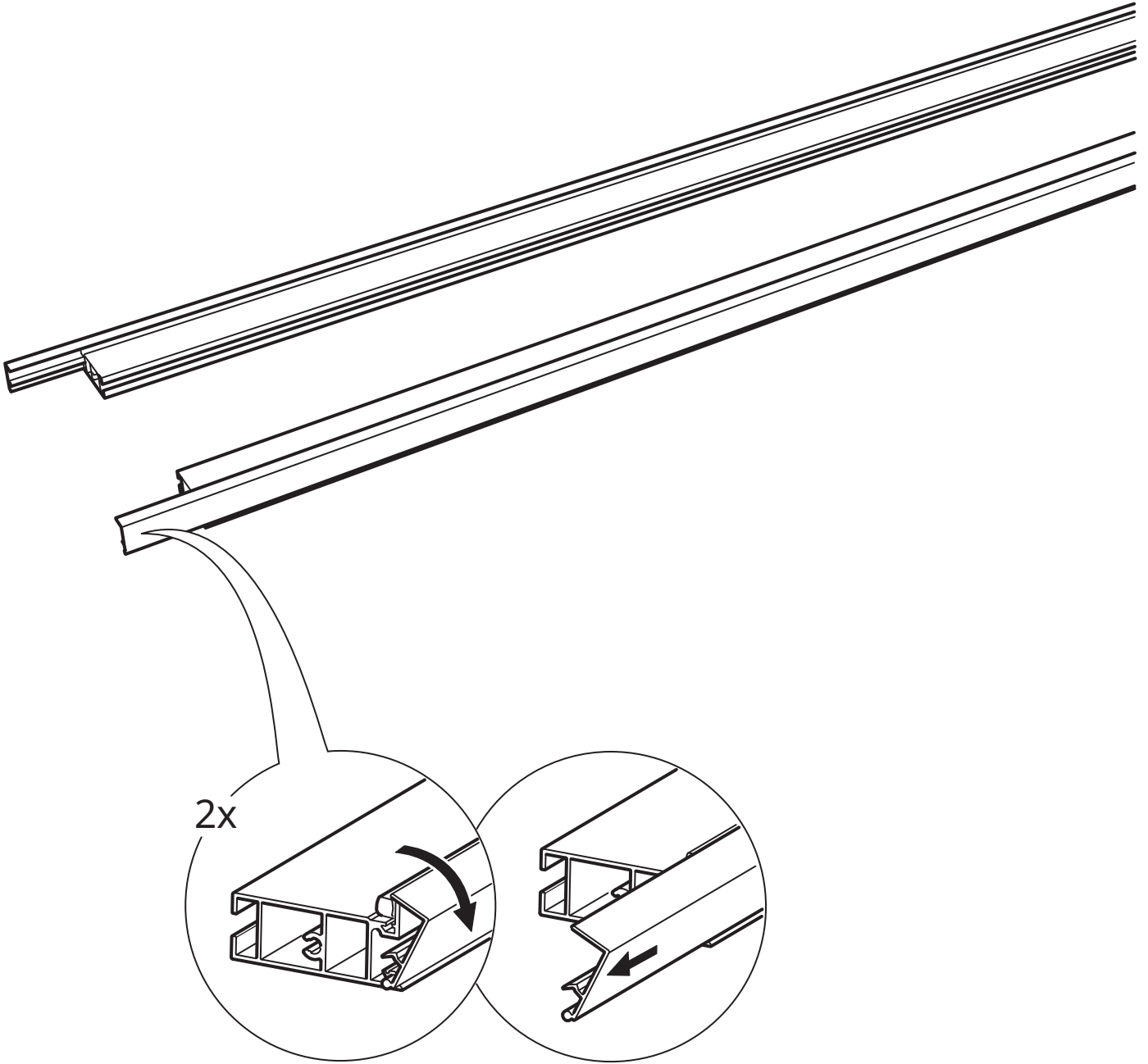

4

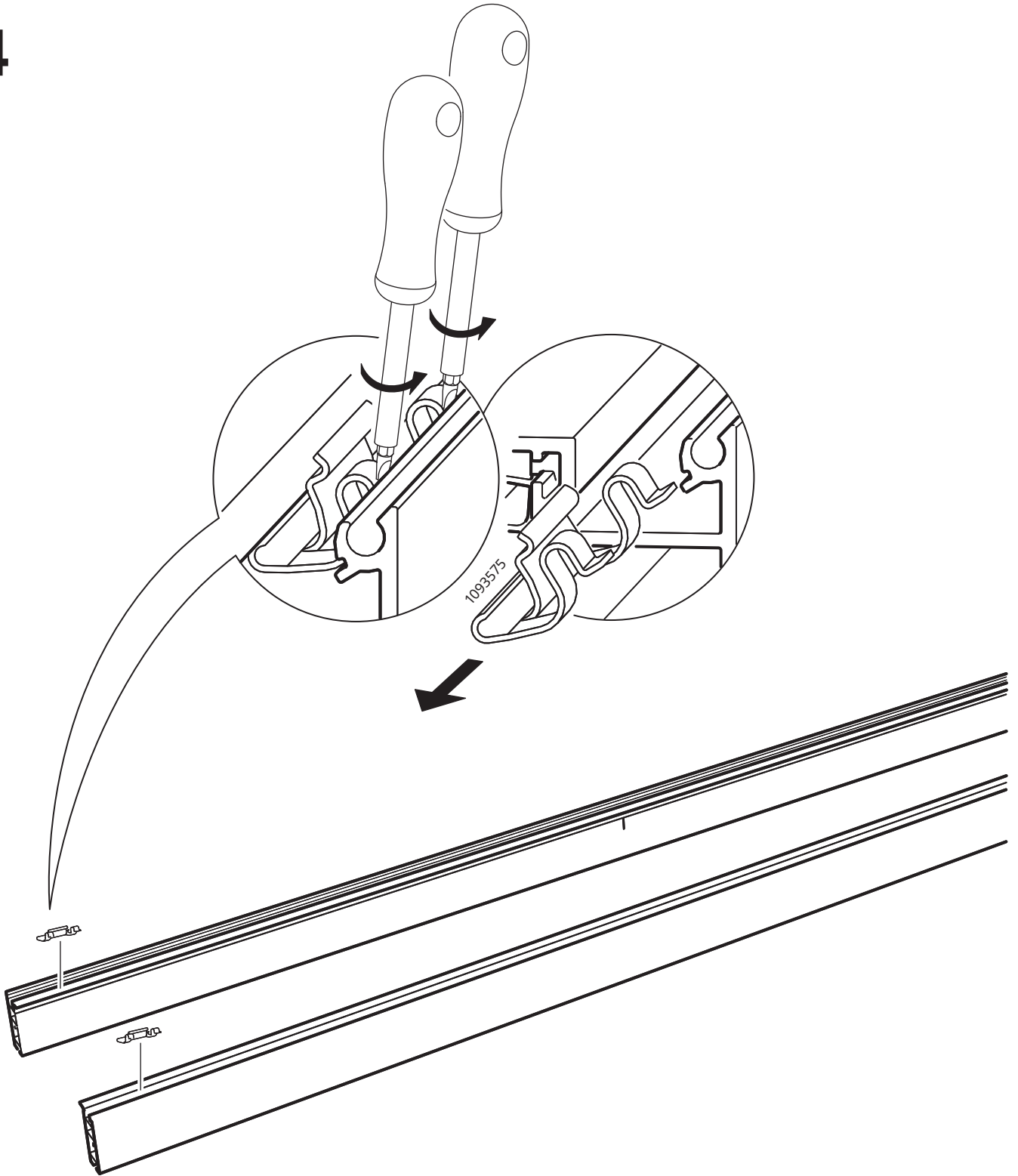

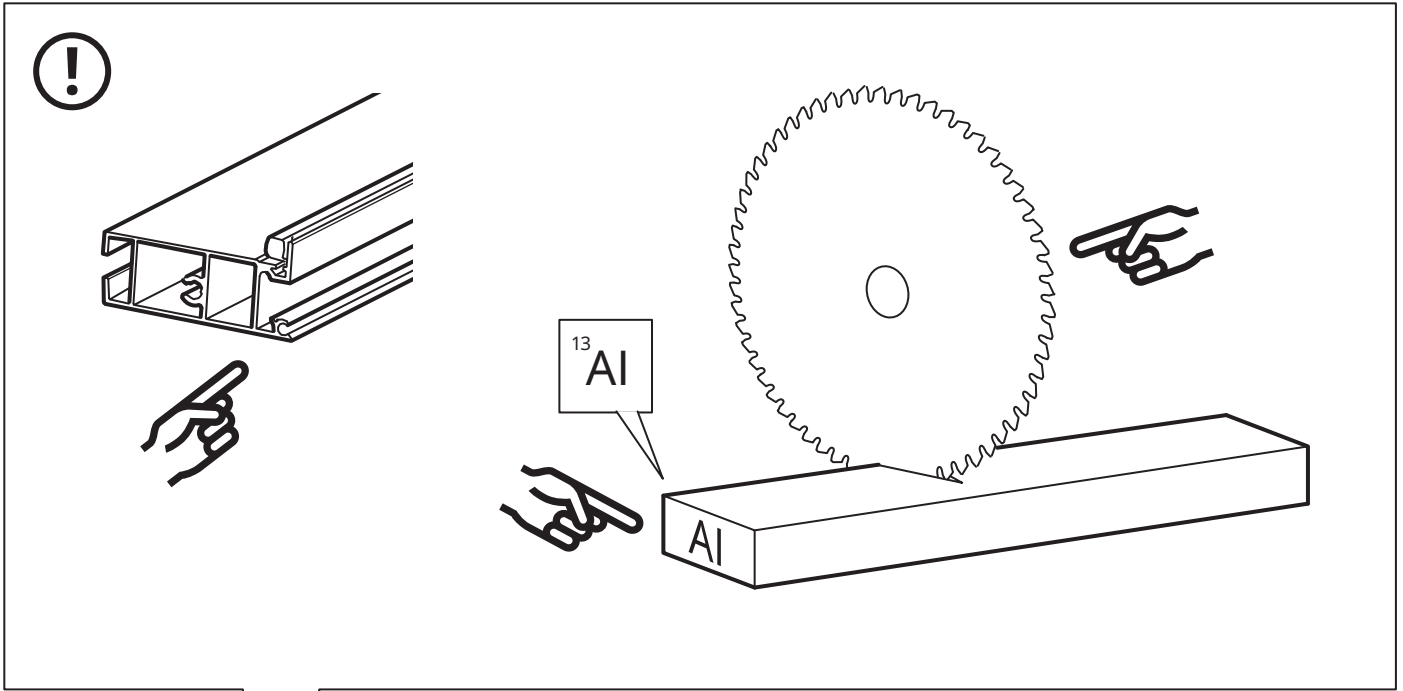

5

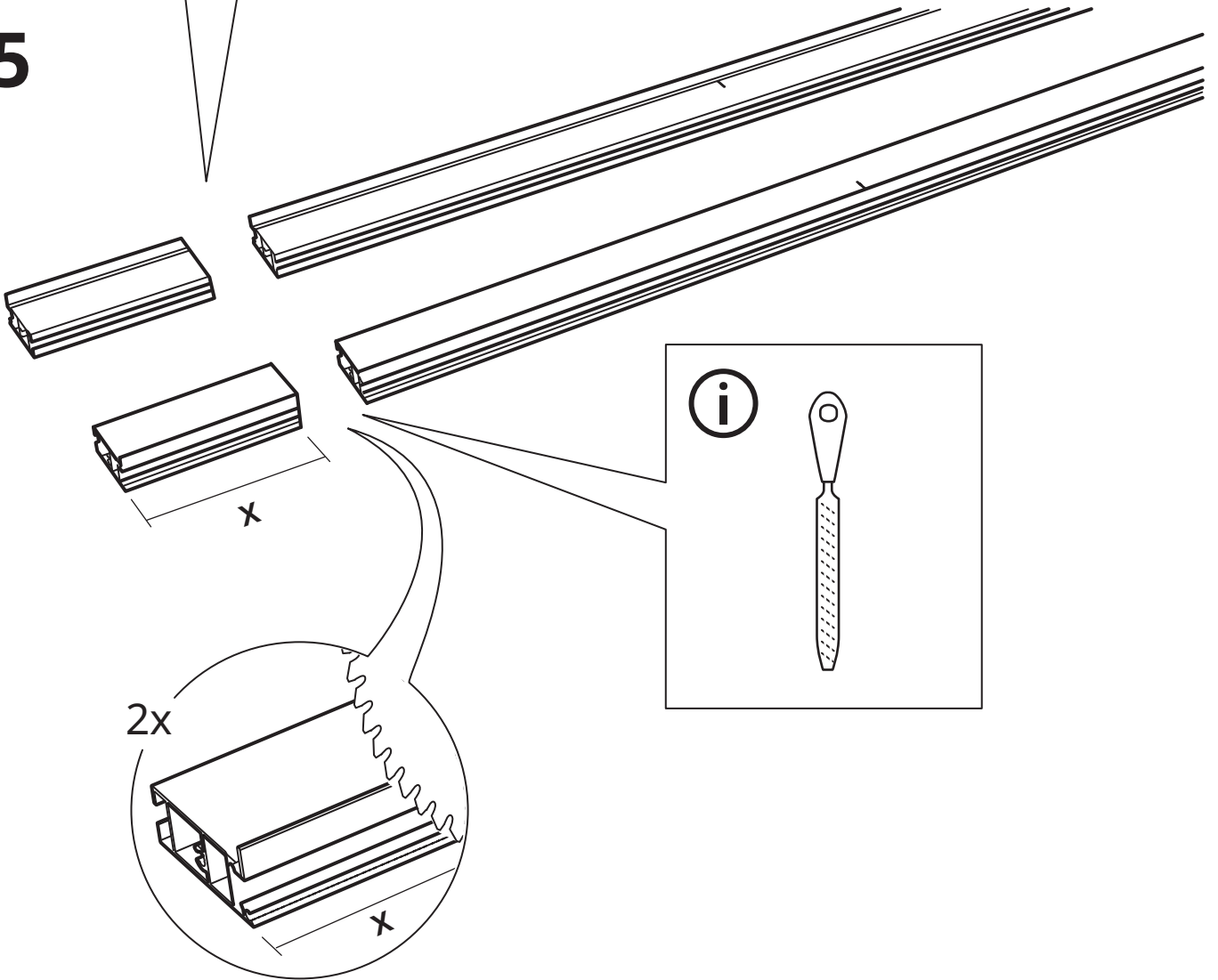

6

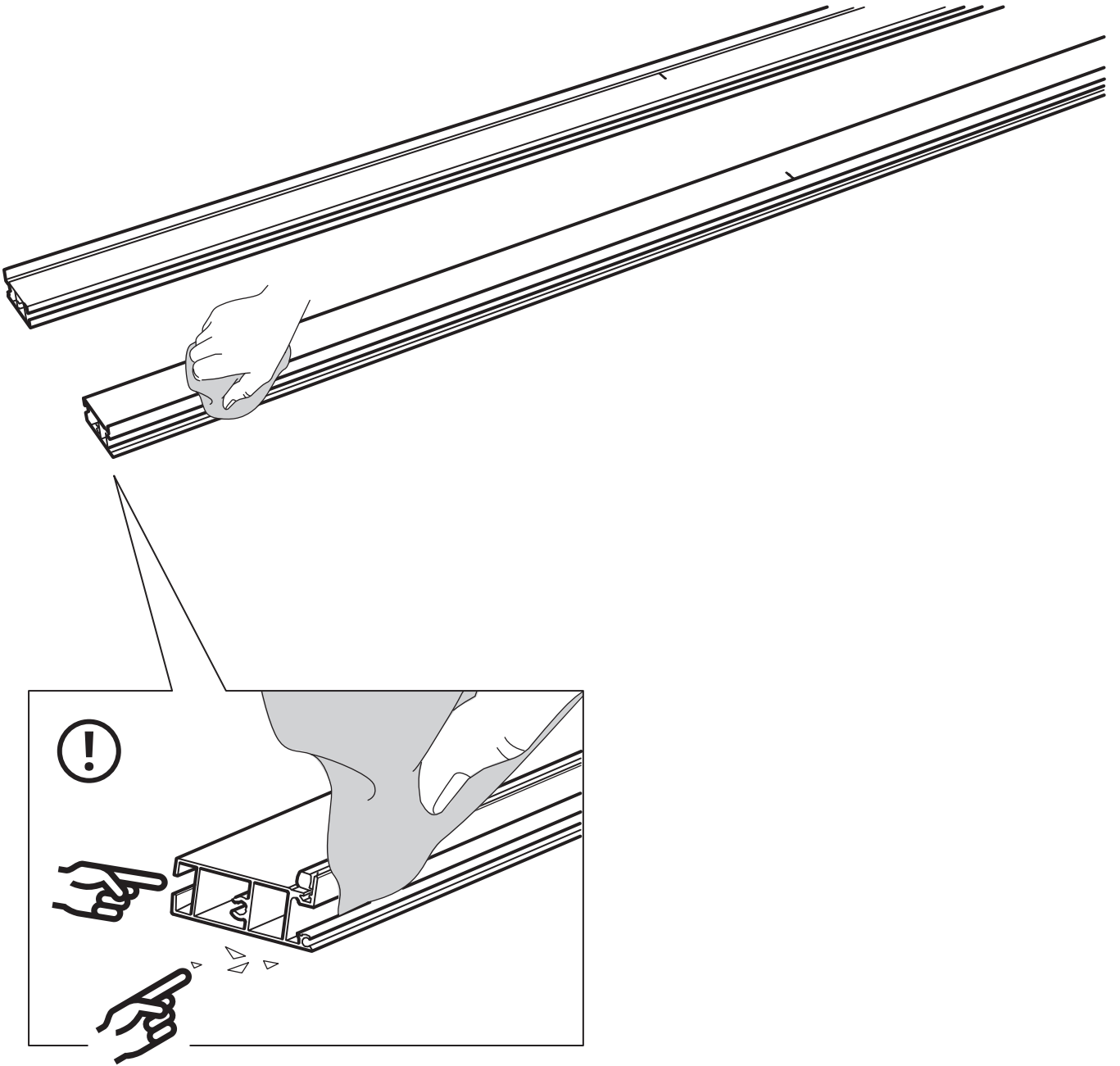

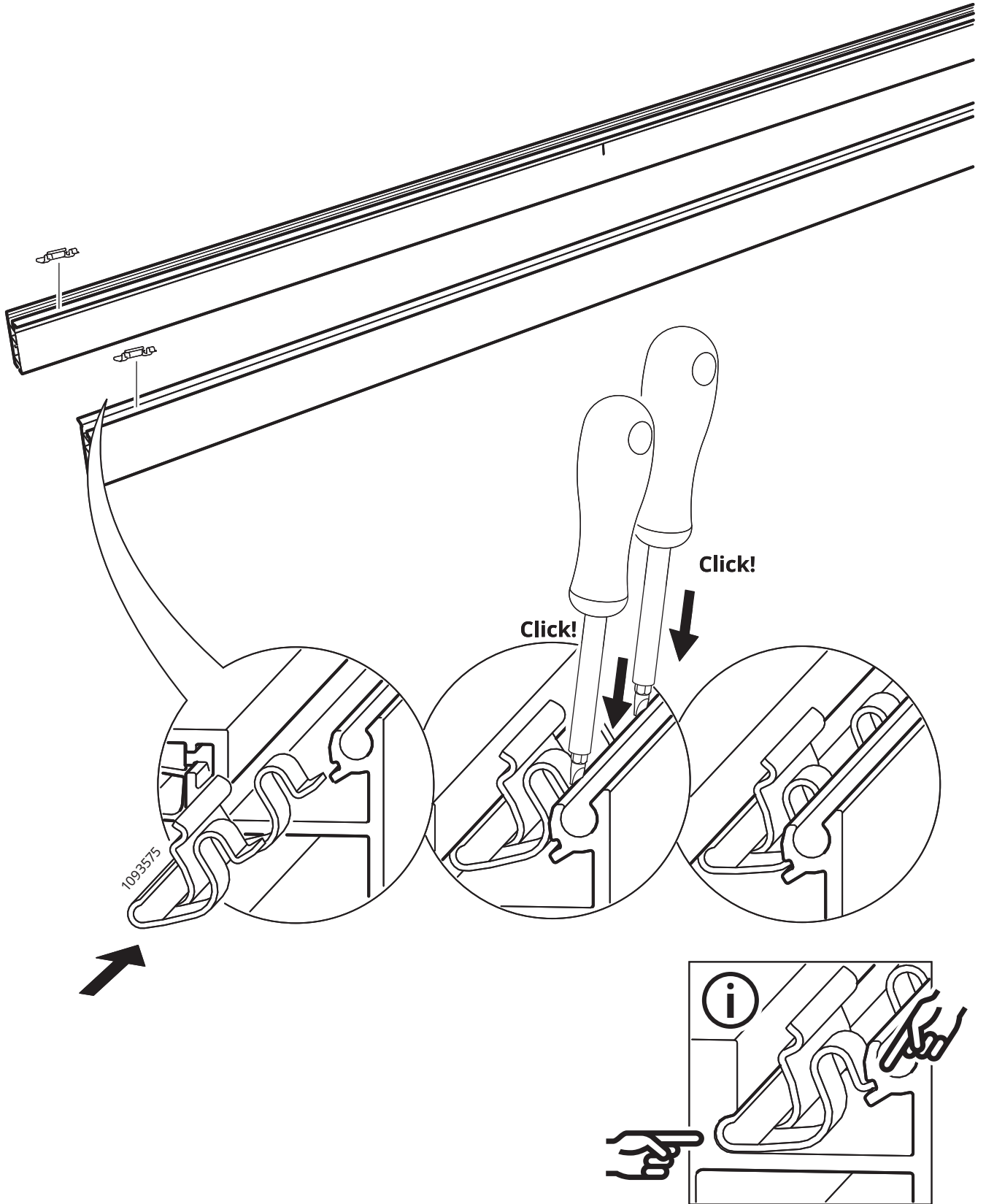

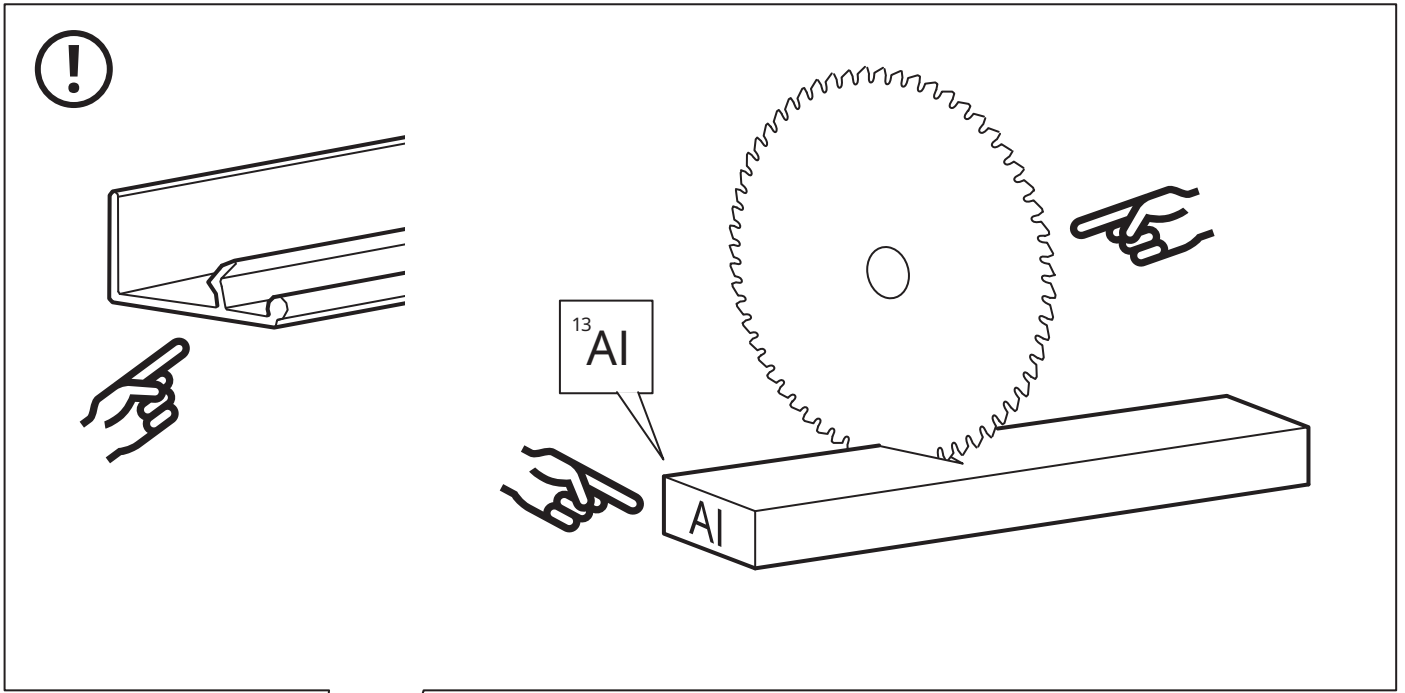

8

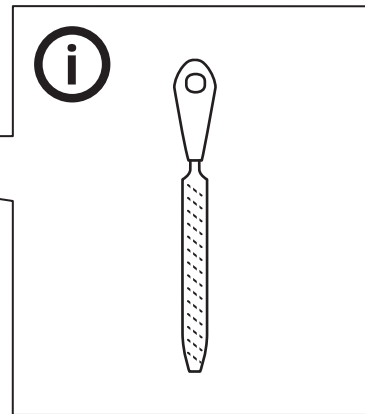
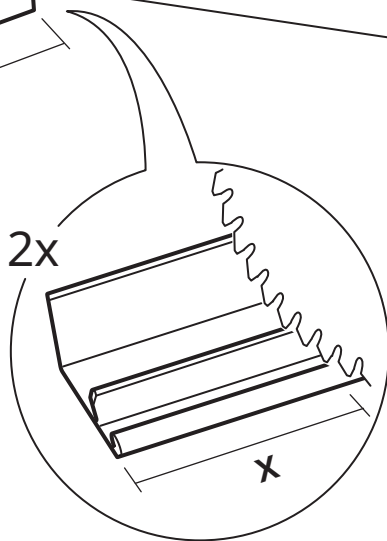
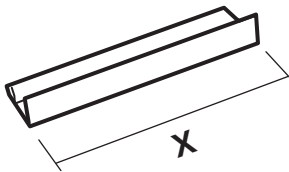
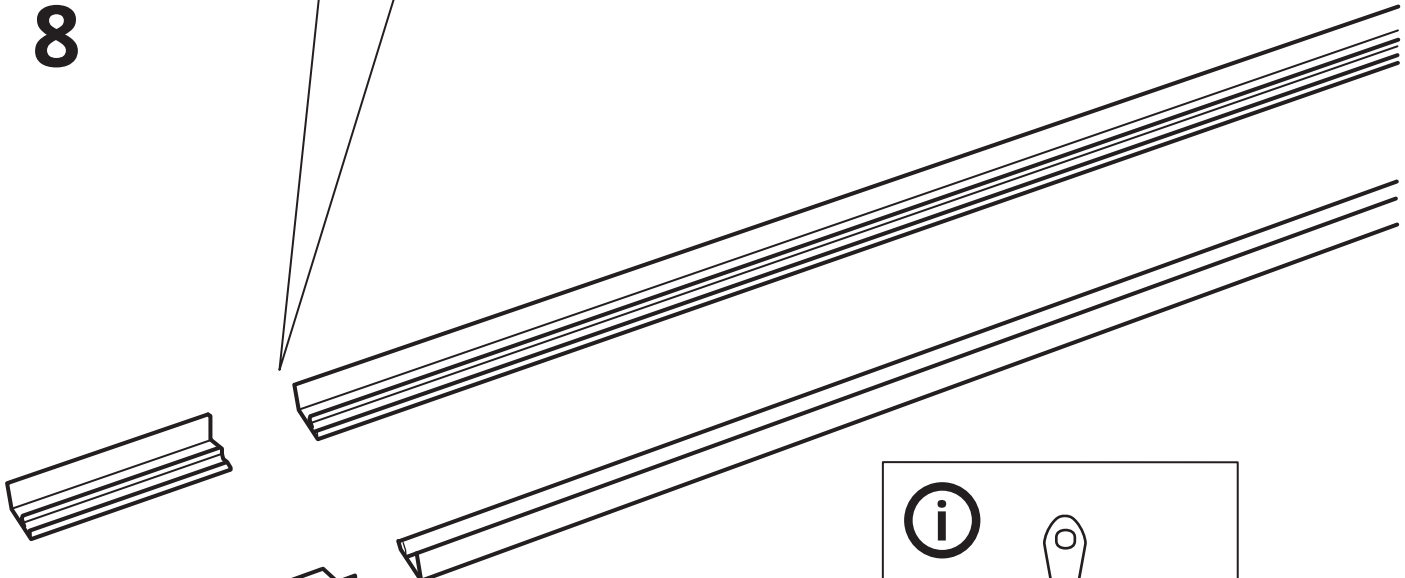

9

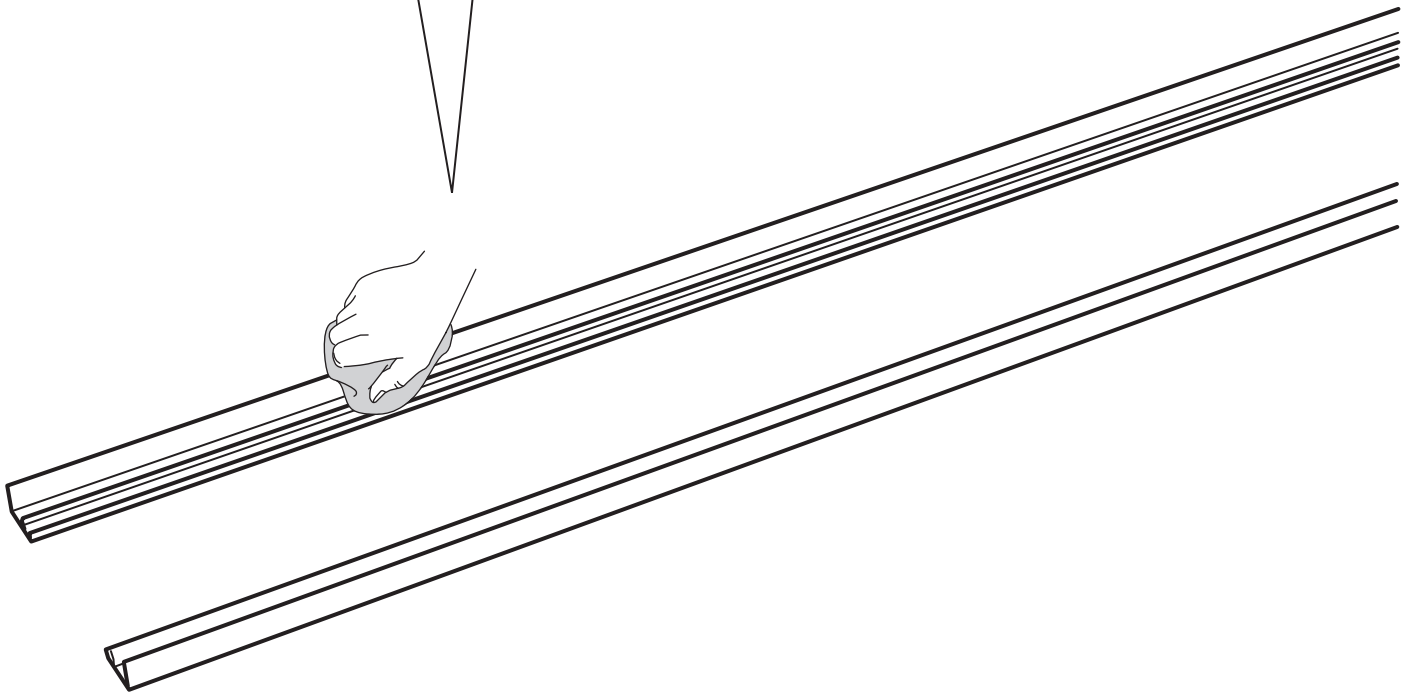
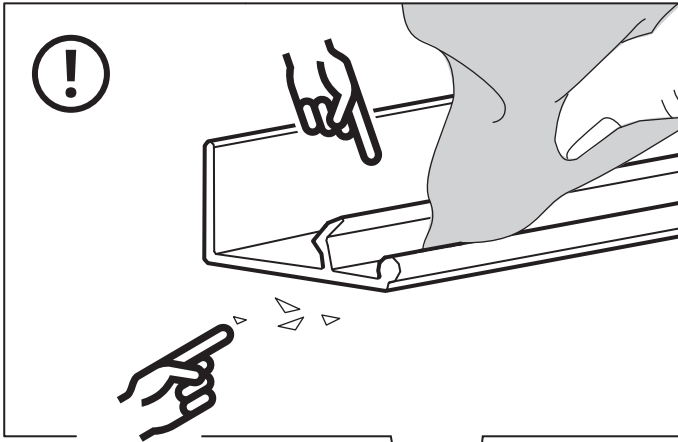

10

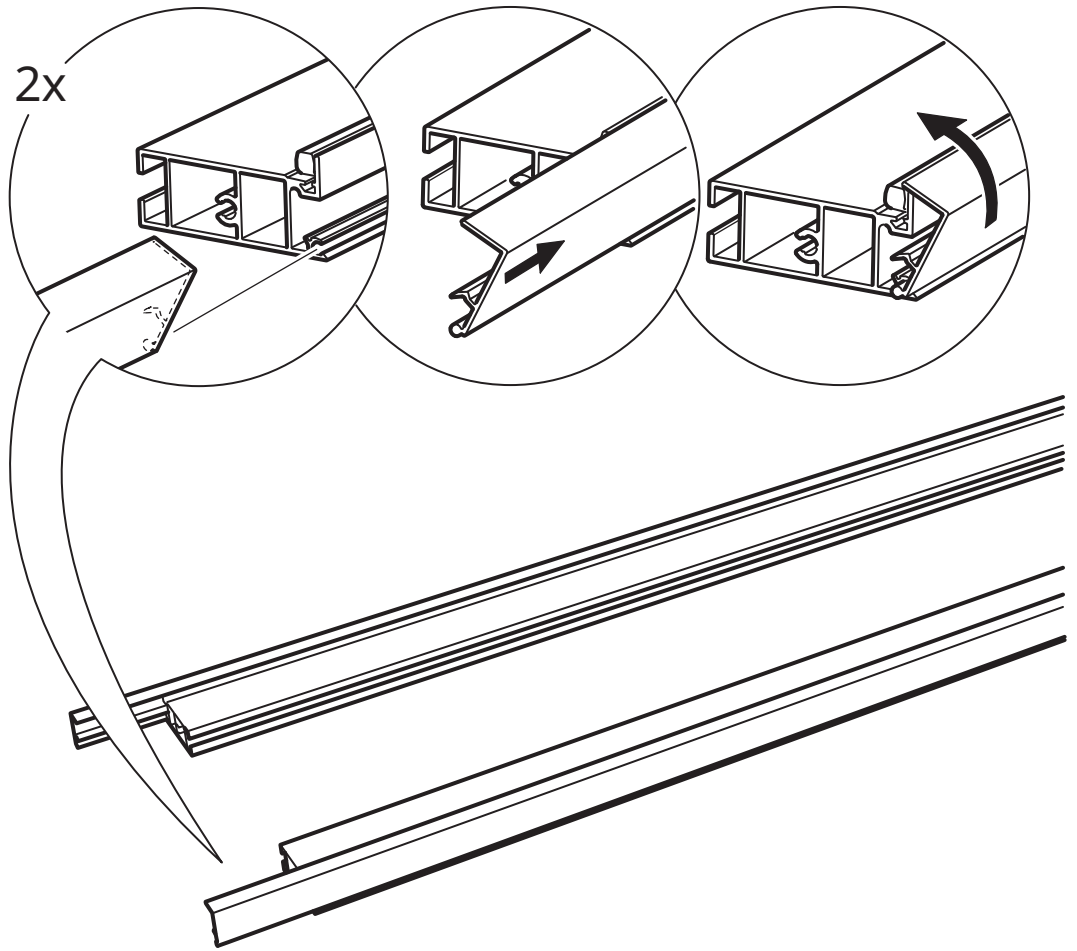

11

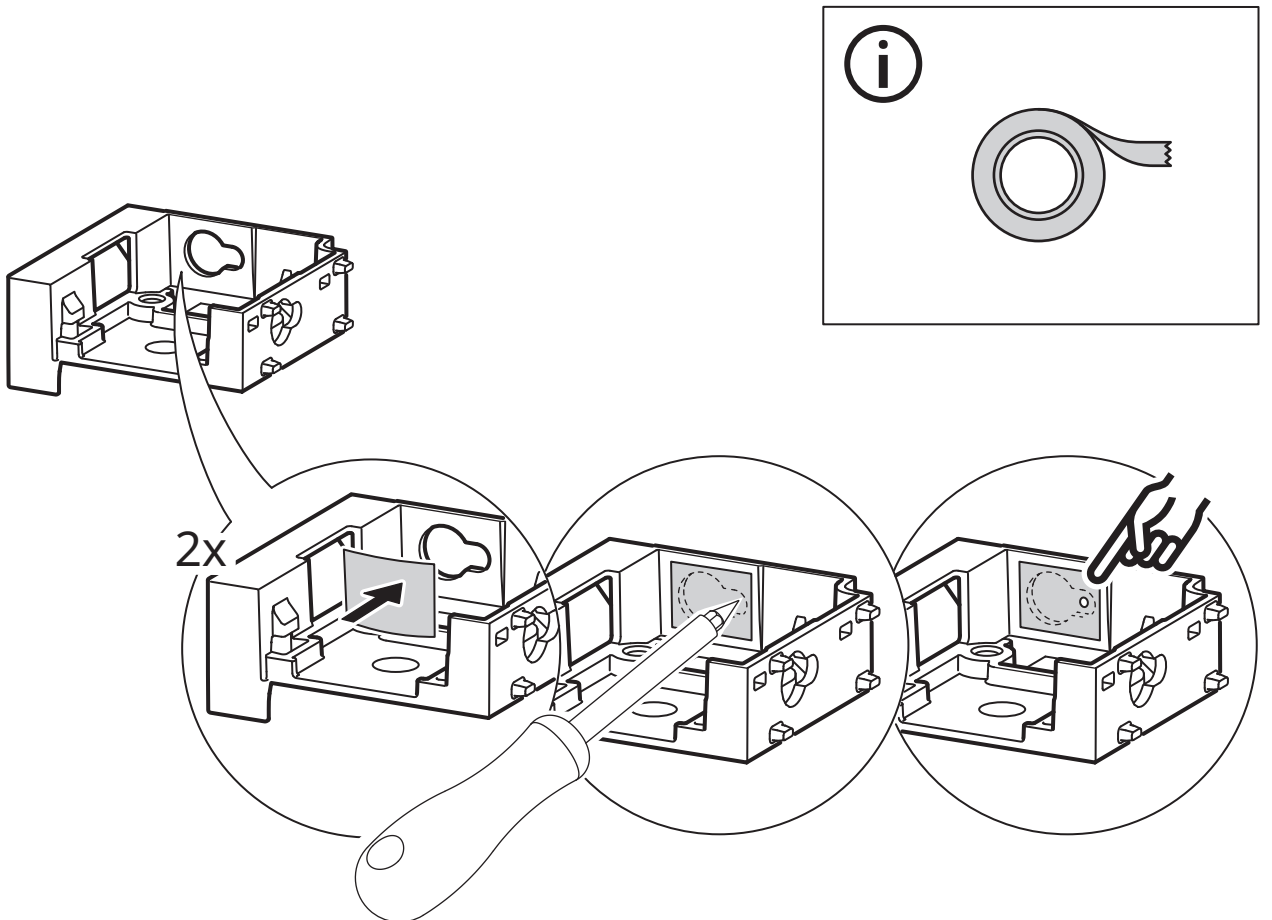

12

